

---

Tome 30

*Novembre* 1992

Numéro 4

---

**La mer**

う み

1992 年 11 月

日 仏 海 洋 学 会

La Société franco-japonaise  
d'océanographie  
Tokyo, Japon

# SOCIÉTÉ FRANCO-JAPONAISE D'OcéANOGRAPHIE

## Comité de Rédaction

(de l'exercice des années de 1992 et 1993)

*Directeur et rédacteur:* M. MURANO

*Comité de lecture:* S. AOKI, T. ARIMOTO, M. HANZAWA, M. HORIKOSHI, M. MAEDA, M. OCHIAI,  
H. SUDO, Y. YAMAGUCHI, T. YANAGI

*Rédacteurs étrangers:* H.J. CECCALDI (France), E.D. GOLDBERG (Etats-Unis), T. ICHIYE (Etats-Unis),  
T.R. PARSONS (Canada)

*Services de rédaction et d'édition:* S. WATANABE, Y. YAMAGUCHI

### Note pour la présentation des manuscrits

**La mer**, organe de la Société franco-japonaise d'océanographie, publie des articles et notes originaux, des articles de synthèse, des analyses d'ouvrages et des informations intéressant les membres de la société. Les sujets traités doivent avoir un rapport direct avec l'océanographie générale, ainsi qu'avec les sciences halieutiques.

Les manuscrits doivent être présentés avec un double, et dactylographiés, en *double interligne*, et au recto exclusivement, sur du papier blanc de format A4 (21×29,7 cm). Les tableaux et les légendes des figures seront regroupés respectivement sur des feuilles séparées à la fin du manuscrit.

Le manuscrit devra être présenté sous la forme suivante:

1° Il sera écrit en japonais, français ou anglais. Dans le cadre des articles originaux, il comprendra toujours le résumé en anglais ou français de *200 mots* environs. Pour les textes en langues européennes, il faudra joindre en plus le résumé en japonais de *500 lettres* environs. Si le manuscrit est envoyé par un non-japonophone, le comité sera responsable de la rédaction de ce résumé.

2° La présentation des articles devra être la même que dans les numéros récents; le nom de l'auteur précédé du prénom *en entier*, en minuscules; les symboles et abréviations standards autorisés par le comité; les citations bibliographiques seront faites selon le mode de publication: article dans une revue, partie d'un livre, livre entier, etc.

3° Les figures ou dessins originaux devront être parfaitement nettes en vue de la réduction nécessaire. La réduction sera faite dans le format 14,5×20,0 cm.

La première épreuve seule sera envoyée à l'auteur pour la correction.

Les membres de la Société peuvent publier 7 pages imprimées sans frais d'impression dans la mesure à leur manuscrit qui ne demande pas de frais d'impression excessifs (pour des photos couleurs, par exemple). Dans les autres cas, y compris la présentation d'un non-membre, tous les frais seront à la charge de l'auteur.

Cinquante tirés-à-part peuvent être fournis par article aux auteurs à titre gratuit. On peut en fournir aussi un plus grand nombre sur demande, par 50 exemplaires.

Les manuscrits devront être adressés directement au directeur de publication de la Société: M. MURANO, Université des Pêches de Tokyo, Konan 4-5-7, Minato-ku, Tokyo, 108 Japon; ou bien au rédacteur étranger le plus proche: H. J. CECCALDI, EPHE, Station marine d'Endoume, rue Batteries-des-Lions, 13007 Marseille, France; E. D. GOLDBERG, Scripps Institution of Oceanography, La Jolla, California 92093, Etats-Unis; T. ICHIYE, Department of Oceanography, Texas A & M University, College Station, Texas 77843, Etats-Unis; ou T. R. PARSONS, Department of Oceanography, University of British Columbia, Vancouver, B. C. V6T 1W5, Canada.

## Distribution of elements in marine sediments: a review and synthesis\*

Noboru TAKEMATSU\*\*

**Abstract:** The importance of Fe-Mn oxides in scavenging minor elements from the water column and fixing them in marine sediments is re-evaluated.

1) Dissolved elements in seawater are taken up by phytoplankton and transported to the sea-floor as settling particles. Biogenous components in settling particles are regenerated during sinking through the water column and the proportion of terrigenous aluminosilicate fraction increases with depth. Below the oxygen minimum zone, Fe-Mn oxides are precipitated on settling particles by microbial mediation and play an important role in scavenging minor elements from seawater.

2) The chemical compositions of oxic deep-sea sediments can be simulated by admixtures of aluminosilicates with average shale composition and Fe-Mn oxides with ferromanganese nodule compositions of four different origins (hydrogenous, oxic diagenetic, suboxic diagenetic and hydrothermal).

3) Near-shore sediments in which neither manganese oxides nor iron sulfides are present have the chemical composition of average shale, because elements transported by settling particles are released during early diagenesis from the sediments as benthic fluxes.

4) In anoxic environments where iron sulfides are formed, chalcophile elements are enriched in the sediments.

5) The present concentrations of many minor elements in seawater and their mean oceanic residence times may be controlled by their ultimate incorporation into Fe-Mn oxides, because anoxic sediments are restricted within narrow limits.

### 1. Introduction

WHITFIELD and TURNER (1979) established the correlation between the concentration ratios of elements in crustal rocks relative to seawater and the mean oceanic residence times of elements, which are a measure of reactivity of elements in the marine environment. On the other hand, LI (1982a) discussed the mean oceanic residence times on the basis of both the concentration ratios of elements in pelagic clays to seawater and those in river water to seawater. WHITFIELD and TURNER (1979) also found a linear correlation between the concentration ratios of elements in the crustal rocks relative to seawater and the electronegativity function

( $Q_{MO} = (\chi_M - \chi_O)^2$ , where  $\chi$  is the electronegativity of the subscripted element). In their discussion on the composition of river water and seawater, they emphasized the importance of the electrostatic interaction of elements with oxygen-dominated mineral lattices during the weathering of the crustal rocks, which produces dissolved solids in river water and clay minerals, and during reverse weathering in marine environments where authigenic silicates, iron and manganese oxides are formed from seawater. On the other hand, LI (1981a) observed a relationship between the concentration ratios of elements in the pelagic sediment to seawater and their first hydrolysis constants for cationic elements and for oxyanionic elements an inverse relationship between the concentration ratios of elements and the first or second dissociation constants of their oxyacids. These relationships

\* Received June 14, 1992

\*\* The Institute of Physical and Chemical Research (RIKEN), Wako-shi, Saitama, 350-01 Japan

are in accordance with the surface complex formation model (SCHINDLER, 1975; BALISTRERI *et al.*, 1981). Although there was a debate on the two concepts (WHITFIELD and TURNER, 1982; LI, 1982b), WHITFIELD and TURNER (1983) and LI (1991) recognized the two concepts as different ways of expressing the chemical bonds between adsorbed elements and oxygen atoms of hydrolyzed solid phases (silicate minerals, oxides, etc.). The surface complex formation model is more mechanistic than the electronegativity function model, although hydrolysis constants for cationic elements and dissociation constants for oxyanionic acids are not necessarily available for all the elements.

In the oceans, many dissolved elements are taken up by phytoplankton and transported to the sea-floor as biogenic settling particles. The elements associated with settling particles are fixed into sedimentary components and otherwise recycled into overlying bottom water during diagenesis. In oxic sediments, the most important adsorbents of elements are iron and manganese oxides, which occur as coatings on sedimentary components (silicate minerals, biogenic silica and calcium carbonates), manganese micro- and macro-nodules (ELDERFIELD *et al.*, 1972; CHESTER *et al.*, 1973; GLASBY, 1975; LI, 1981a; STOFFERS *et al.*, 1981; GLASBY *et al.*, 1987; PIPER, 1988; KUNZENDORF *et al.*, 1989). In anoxic environments, iron sulfides and humic substances play an important role in fixing elements into sediments (VINE and TOURTELOT, 1970; BRUMSACK, 1980; LEVENTHAL *et al.*, 1982; CALVERT and PRICE, 1983; JACOBS *et al.*, 1987).

In this study, ferromanganese concretions are chosen as the representative hydrogenous product of oxic marine environments and black shales as that of anoxic environments, and the behavior of elements in marine environments is discussed in relation to the mean oceanic residence time.

## 2. Enrichment of elements in oxic pelagic sediments relative to the crustal rocks

Pelagic sediments are considered to be the ultimate sink of many elements as well as ferromanganese concretions (LI, 1981a). However, ferromanganese concretions are better models

than sediments to investigate the removal mechanisms of minor elements in oxic marine environments, because most constituents of ferromanganese concretions are of marine origin. On the other hand, pelagic sediments are the mixture of aluminosilicate minerals transported from land, biogenic calcium carbonate and silica, humic matter, and manganese and iron oxides which occur as coatings on the sedimentary components and as manganese micronodules. The chemical composition of the hydrogenous fraction of pelagic clays is similar to that of the associated ferromanganese concretions (PIPER *et al.*, 1979; APLIN and CRONAN, 1985; PIPER *et al.*, 1987).

As described above, WHITFIELD and TURNER (1979) established the correlation between the concentration ratios of elements in the crustal rocks relative to seawater and their mean oceanic residence times. The concentration ratios of elements in ferromanganese concretions relative to seawater are plotted against those in the crustal rocks relative to seawater (Fig. 1). In the abscissa, elements are therefore roughly arranged in decreasing order of their mean oceanic residence times. The concentration data of ferromanganese concretions, the crustal rocks and seawater are mainly from the compilations given by BATURIN (1988), MASON and MOORE (1982) and BRULAND (1983), respectively. In Fig. 1, elements plotted above the 1: 1 line indicate that they are concentrated in ferromanganese concretions more than in the crustal rocks. Elements located along the 1: 1 line are elements which are contained in aluminosilicate minerals transported from land or elements of which concentration ratios in ferromanganese concretions are similar to those in the crustal rocks.

Cationic minor elements are adsorbed on iron and manganese oxides and some of them are substituted for manganese in edge-shared  $[\text{MnO}_6]$  octahedra (BURNS and BURNS, 1976; BURNS *et al.*, 1983). According to LI (1981a), adsorption affinities of cationic elements on oxides depend on their first hydrolysis constants. In Fig. 2, concentration ratios of cationic elements in ferromanganese concretions are plotted against their first hydrolysis constants. The hydrolysis constants are mainly from the compilation given by SMITH and MARTELL (1976). The most

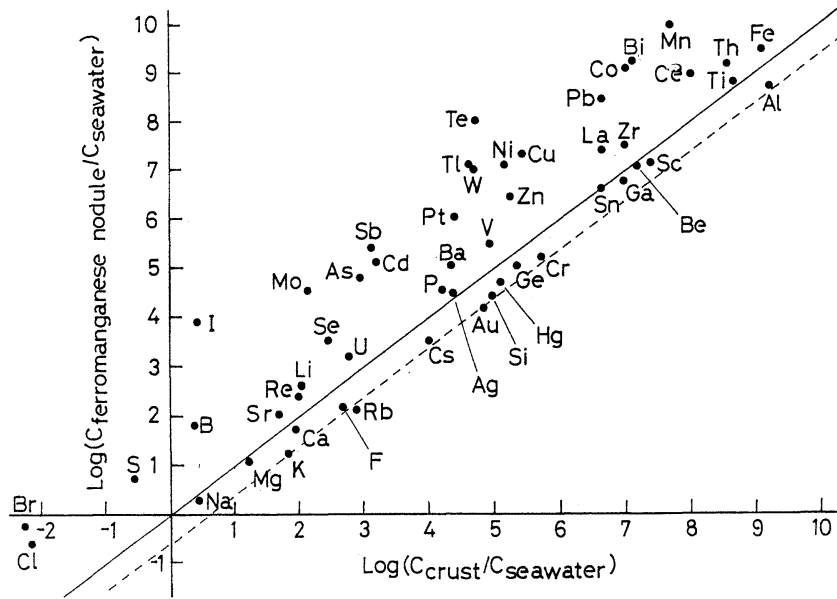

Fig. 1. Concentration ratios of elements in ferromanganese nodules relative to seawater versus those in the crustal rocks to seawater. A dashed line shows the case where the lithogenous fraction is 25% in concretions and the oxide fraction is only a diluent.

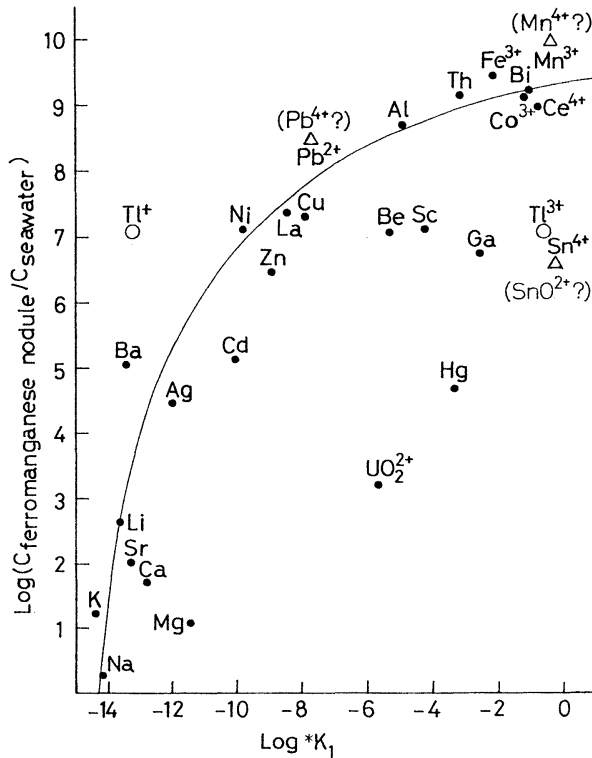

Fig. 2. Concentration ratios of elements in ferromanganese nodules relative to seawater versus the first hydrolysis constants of elements.

enriched elements such as Mn, Fe, Co, Ce and Pb are oxidized to higher valence states after adsorption and are present as oxides in concretions (GOLDBERG, 1965; GLASBY, 1975). The large negative deviations of Ga, Sn, Hg and U from the main trend are attributed to their speciation in seawater. The species of Ga, Sn, Hg and U in seawater are considered to be  $\text{Ga}(\text{OH})_4^-$ ,  $\text{SnO}(\text{OH})_3^-$ ,  $\text{HgCl}_4^{2-}$  and  $\text{UO}_2(\text{CO}_3)_3^{4-}$ , respectively (BRULAND, 1983). Such anionic species may not be effectively adsorbed on oxides. Silver does not deviate negatively to a great extent, although it occurs as  $\text{AgCl}_2^-$  in seawater. The first hydrolysis constant of Au is not available but the low content of Au in ferromanganese concretions relative to the crustal rocks is attributed to the presence of  $\text{AuCl}_2^-$  in seawater (GOLDBERG, 1987). Platinum is present in seawater as  $\text{PtCl}_4^{2-}$  but it is markedly enriched in ferromanganese concretions because Pt(II) is oxidized to Pt(IV) on manganese oxides (GOLDBERG, 1987). The oxidation state of thallium is unknown but mixed valence states of  $\text{Tl}^+$  and  $\text{Tl}^{3+}$  may occur in ferromanganese concretions judging from its concentration ratio and the first hydrolysis constants of mono- and tri-valent thallium. The positive deviation of Ba may be attributed to the presence of barite in concretions (BOSTROM *et al.*, 1973; LYLE *et al.*, 1977; DEHAIRS *et al.*, 1980), while the negative deviations of Mg and Ca remain unexplained.

Oxyanionic elements (B, Si, P, S, V, Cr, Ge, As, Se, Mo, Sb, Te, I, W, Re, etc) except Te and W are generally low in their concentration ratios and have long mean oceanic residence times, compared with cationic transition metals (Fig. 1). The low concentration ratios of oxyanionic elements in ferromanganese concretions have been explained in terms of a lack of lattice substitution in edge-shared  $[\text{MnO}_6]$  octahedra after adsorption (TAKEMATSU, 1987). Adsorption affinities of oxyanionic elements are inversely dependent on the first or second dissociation constants of their acids (LI, 1981a). For some elements occurring in seawater as oxyanions, there is a correlation between their concentration ratios in ferromanganese concretions and the first or second dissociation constants of their acids (TAKEMATSU *et al.*, 1990). An exception to this is

tungsten which may form manganese or iron compounds of tungstate on the Fe-Mn oxide surface (LI, 1981a). Tellurium has been considered to be present in seawater as  $\text{HTeO}_3^-$  or  $\text{TeO}_3^{2-}$  (BRULAND, 1983). However, according to LEE and EDMOND (1985), Te(VI) is more abundant than Te(IV) in seawater and would be present as  $\text{Te}(\text{OH})_6$ . The reactivity of Te in seawater is similar to that of Po, which occurs as  $\text{Po}(\text{OH})_4$  and has a short residence time, reflecting the position of neighbors in Group VIb of the Periodic Table. The high reactivity of Te in the water column is consistent with the high concentration ratio of Te in ferromanganese concretions.

The above concept is not applicable to fully hydrolyzed elements which occur in seawater as undissociated acids or hydrolyzed anions. Among them, B, Si, Ge and Sb are included, whose predominant species in seawater are considered to be  $\text{B}(\text{OH})_3$ ,  $\text{Si}(\text{OH})_4$ ,  $\text{Ge}(\text{OH})_4$  and  $\text{Sb}(\text{OH})_6^-$ , respectively (BRULAND, 1983). Antimony in the water column exhibits little variations in concentrations with depth (MIDDELBERG *et al.*, 1988) and has a residence time of ca.  $10^5$  yr (LI, 1982a). In accordance with this, Sb has a relatively weak adsorption affinity for marine sediments, although the distribution coefficient of Sb for manganese oxides (ca.  $5 \times 10^4$  ml/g) is relatively high (LI *et al.*, 1984; SANTSCHI *et al.*, 1984). The species of Sb in seawater is considered to be  $\text{Sb}(\text{OH})_6^-$  but its adsorption mechanism on oxides is unknown. Boron is conservative in the water column and has the oceanic residence time of ca.  $10^7$  yr (LI, 1982a). According to GOLDBERG and GLAUBIG (1985), boric acid exhibits an adsorption maximum on iron oxides at about pH 8 and the distribution coefficient is ca.  $10^2$  (ml/g), which is almost equal to the concentration ratio of B in ferromanganese concretions (Fig. 1). The adsorption affinity of silicate on iron oxides is somewhat lower than that of arsenate (BALISTRERI and CHAO, 1987). This is consistent with the fact that the concentration ratio of silicate in ferromanganese concretions is a little lower than that of arsenate (Fig. 1). However, the most of Si in ferromanganese concretions is present as aluminosilicate minerals. The average lithogenous (alumino-silicates) fraction of concretions is about 25% (CALVERT *et al.*, 1978;

TAKEMATSU, 1979; BISCHOFF *et al.*, 1981). In Fig. 1, the case where the lithogenous fraction is 25% in concretions and the oxide fraction is only a diluent is shown by a dashed line. Inorganic germanium exhibits the same vertical distribution as Si in the water column (FROELICH and ANDREAE, 1981) and probably behaves like Si in marine environments.

It is interesting to investigate whether elements located around the line of 25% lithogenous fraction are in the aluminosilicate phase or in the oxide phase. There are two methods to distinguish them: investigation of relationships between Si or Al and elements in nodules, and selective dissolution of the oxide phase using an acid-reducing agent (CHESTER and HUGHES, 1967). By selective dissolution, BISCHOFF *et al.* (1981) claimed the presence of Al, Si, K and Na in the authigenic phillipsite fraction, and MOORBY and CRONAN (1981) suggested the association of Al, Ti, Cr and some Ca with aluminosilicates. The elements reported to be associated with aluminosilicates from inter-element relationships are K, Ca, Rb, Sr and Zr (CALVERT and PRICE, 1977; CALVERT *et al.* 1978). LI (1982c) concluded that Al, Si, Sc, Ga, Cr, Be, Na, K, Rb and Cs are preferentially concentrated in aluminosilicates. However, this conclusion was derived from the fact that the enrichment factors of these elements in nodules, relative to pelagic clays are close to one. PIPER *et al.* (1979) found by selective dissolution that the concentration of Sc in the lithogenous fraction is 2.5 times higher than that in the bulk nodules. This indicates that the abundance ratio of Sc in the lithogenous and oxide fractions is about 3:2 if the lithogenous fraction of nodules is 25%. According to BISCHOFF *et al.* (1981), 42% of Al, 12% of Si, 84% of Na, 47% of K, 72% of Mg, 66% of Ca and 51% of Ti in nodules are leached by acid-reducing agent attack. SATO *et al.* (1989) measured the contents of Na, K, Mg and Ca in almost pure manganese oxides precipitated from seawater, and concluded that a considerable part of Na, Mg and Ca in marine ferromanganese concretions are in the oxide fraction as charge-balancing cations and that the most of K is associated with aluminosilicates. In short, major parts of Al, Si, K, Rb, Ti and Cr in nodules are associated with

aluminosilicates. Sodium, Mg, Ca and probably Sc are in the oxide phase as well as in the aluminosilicate phase. However, it is necessary to investigate whether the soluble fraction of Al and Ti in nodules by acid-reducing agent attack (BISCHOFF *et al.*, 1981) is leached from authigenic aluminosilicates or from the oxide phases or from aluminosilicates transported from land.

LI (1981b) assumed that aluminosilicate minerals transported to the ocean by rivers and through the atmosphere have the composition of average shale. If this is the case, pelagic sediments are a mixture of silicate minerals with typical shale composition and authigenic components in marine environments. If ferromanganese oxides play a major role in fixing trace elements transported by settling particles in the deep-sea sediment, elements enriched in ferromanganese concretions have higher contents in pelagic sediments than in shales. In Fig. 3, the concentration ratios of elements in pelagic sediments and average shale relative to seawater are plotted against those in the crustal rocks relative to seawater. The concentrations of elements in pelagic sediments and average shale are from the compilations given by BATURIN (1988) and MASON and MOORE (1982), respectively. The elements having higher contents in pelagic sediments relative to average shale are Mn, Cu, Mo, W, Ba, Co, Pb, Ni, La, Ce, P, Zn, Sr, Ba and I. All of them are concentrated in ferromanganese concretions, although Ba and Sr occur in pelagic sediments as barite and carbonates, respectively. The contents of As, Sb and Bi in pelagic sediments are almost equal to those in average shale, although these elements are enriched in ferromanganese concretions relative to the crustal rocks, because the contents of these elements in shales are high relative to the crustal rocks.

Boron, S, As, Se, Sb, I and Bi are much enriched in shales relative to the crustal rocks. The enrichment of these elements in shales are primarily attributed to the so-called magmatic volatiles, which include H<sub>2</sub>O, CO<sub>2</sub>, H<sub>2</sub>S, HCl, HBr, HI, B, As, Se, Sb, Bi, Hg and so forth (WEDEPOHL, 1969) but secondarily to their incorporation into organic-rich reducing sediments, as described below.

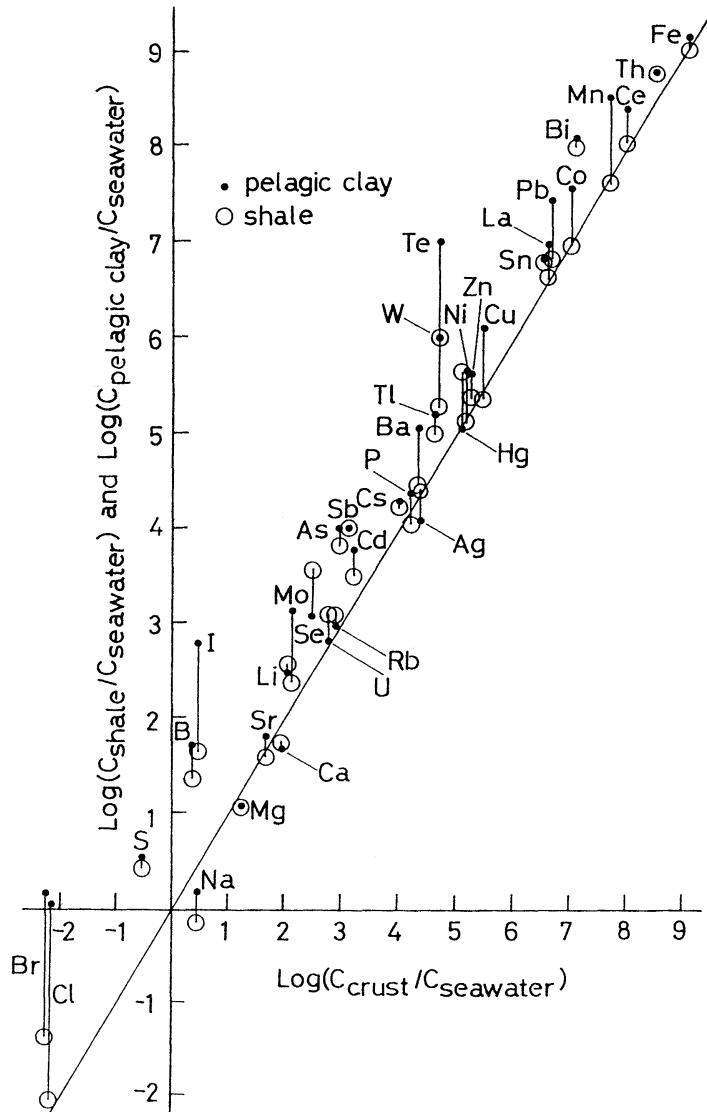

Fig. 3. Comparison between concentration ratios of elements in pelagic clay relative to seawater and those in average shale to seawater.

### 3. Enrichment of elements in anoxic sediments relative to the crustal rock

In near-shore environments, sediments are more reducing than in deep-sea waters, because settling particles reach the bottom before the decomposition of organic matter, and anoxic diagenesis occurs in the near-shore sediments. On the Southwest Africa (Namibia) shelf and in the Gulf of California, organic-rich reducing diatomaceous sediments occur as a result of high plankton productivity by intense upwelling

of nutrient-rich deep water. In the sediments, As, Se, Br, Mo, Cd, Sb, I, Hg, Bi and V are concentrated relative to average shale (Fig. 4) (BRONGERSMA-SANDERS *et al.*, 1980; CALVERT and PRICE, 1983; BRUMSACK, 1986). These are the elements enriched in shales relative to the crustal rocks, as shown in Fig. 3. In restricted basins such as the Black Sea, the Cariaco Trench and Saanich Inlet (British Columbia), where the  $O_2/H_2S$  boundary lies within the water column, metal sulfides are further added to the



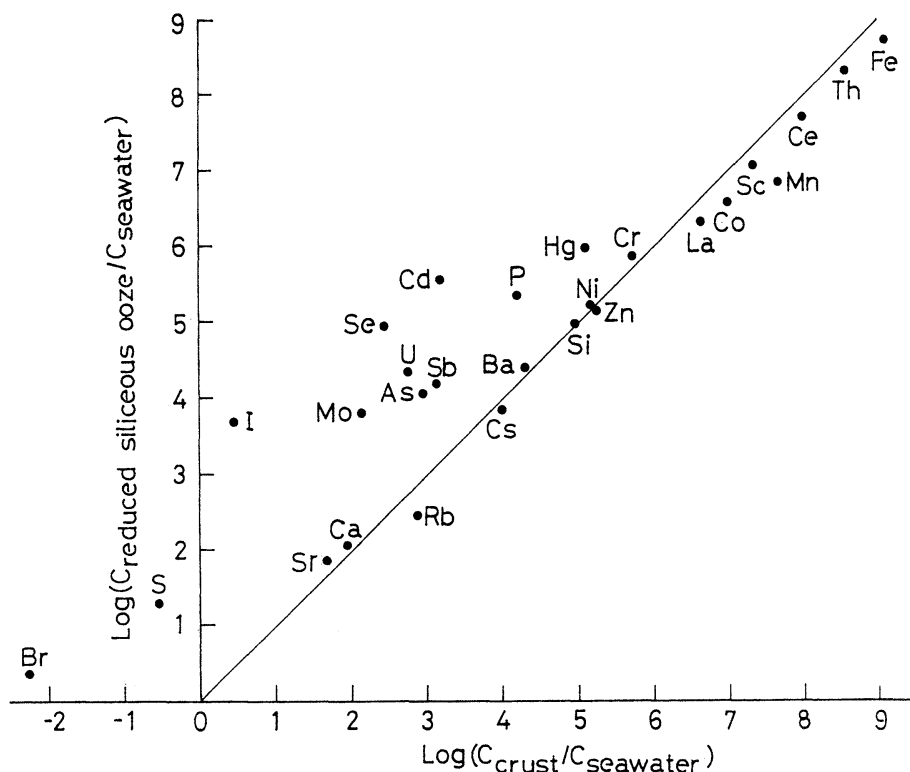

Fig. 4. Concentration ratios of elements in reduced siliceous ooze relative to seawater versus those in the crustal rocks to seawater.

sediments from the water column (JACOBS *et al.*, 1987). The products as a result of anoxic diagenesis in the area where the supply of biogenic settling particles is large relative to that of detrital aluminosilicates have the chemical composition similar to black shales (BRUMSACK, 1980). As there is no adequate compilation of elements in the marine reducing sediment, a near-shore sediment and organic-rich shales are chosen from Geostandards. In Fig. 5, the concentration ratios of elements in Geostandards of a near-shore sediment (MAG-1) and shales (SCo-1, SGR-1 and SDO-1) relative to seawater are plotted against those in the crustal rocks relative to seawater, except some elements of which concentrations are within a factor of 2, compared to the crustal rocks. MAG-1 is a gray-brown fine-grained clayey mud from the is the Wilkinson Basin of the Gulf of Maine; SCo-1 is the Upper Cretaceous silty marine shales; SGR-1 is an oil shale from the

Mahogany zone of the Green River Formation of Eocene age (carbonate lake) and SDO-1 is an organic-rich silt shale representative of the relatively radioactive, metalliferous Devonian age black shales (GOVINDARAJU, 1989). The organic carbon contents of MAG-1, SCo-1, SGR-1 and SDO-1 are 2.15, 0.81, 3.16 and 9.95%, respectively, and those of CO<sub>2</sub> are 7.88, 2.97, 11.58 and 1.01%, respectively. The trend of elemental enrichments in these Geostandards is similar to that in modern organic-rich reducing marine sediments (Fig. 4). Arsenic, Se, Sb, Te and Bi are enriched relative to the crustal rocks. These elements are chalcophile and positioned in Groups Vb and VIb of the Periodic Table. The cause of the enrichment of As, Se and Sb has been well documented concerning the Cretaceous-Tertiary boundary problem (KEITH, 1982; SCHMITZ, 1985, 1988; STRONG *et al.*, 1987; GILMOUR and ANDERS, 1989). Arsenic, Se, Sb and probably Te and Bi are scavenged from the

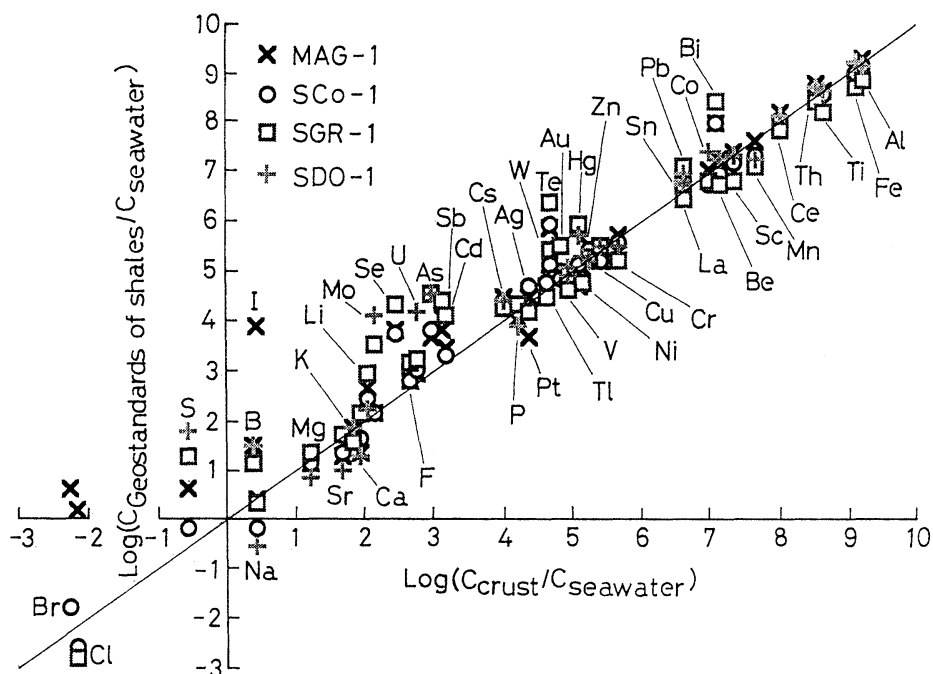

Fig. 5. Concentration ratios of elements in Geostandards of shales relative to seawater versus those in the crustal rocks to seawater.

water column by degraded organic matter (KNAUSS and KU, 1983; MASUZAWA *et al.*, 1989) and fixed in organic-rich reducing sediments as sulfides and organometallic compounds (HOWARD, 1977; CUTTER, 1985; BELZILE and LEBEL, 1986; EDENBORN *et al.*, 1986; TAKAYANAGI and BELZILE, 1988).

Molybdenum is enriched more than an order of magnitude in modern organic-rich reducing sediments than in average shale (Fig. 4) and in ancient black shales (VINE and TOURTELOT, 1970; BRUMSACK, 1980; LEVENTHAL and HOSTERMAN, 1982). Molybdenum in organic-rich reducing sediments is considered to be either coprecipitated with Fe sulfides (MANHEIM, 1961; BERTINE, 1972; PILIPCHUK and VOLKOV, 1974; MALCOLM, 1985) or associated with organic matters (NISSENBAUM and SWAINE, 1976; BRUMSACK and GIESKES, 1983). However, Mo is little concentrated in plankton in spite of its high concentration in seawater ( $11 \mu\text{g}/\text{l}$ ) (MARTIN and KNAUER, 1973; LI, 1984; FRANCOIS, 1988). Therefore, it is assumed that Mo diffuses from the sea water column into reducing sediments and is incorporated into organic

matter or sulfides after reduction to the +5 or +4 valence state (BRONGERSMA-SANDERS *et al.*, 1980; BRUMSACK *et al.*, 1983; FRANCOIS, 1988).

Uranium is also extremely enriched in organic-rich reducing sediments, especially in phosphatized sediments (MANHEIM, 1961; VEEH, 1967; VEEH *et al.*, 1974; RONA and JOENSU, 1974; BRONGERSMA-SANDERS *et al.*, 1980; CALVERT and PRICE, 1983) and in ancient black shales (VINE and TOURTELOT, 1970; LEVENTHAL and HOSTERMAN, 1982). The proposed mechanism for uranium enrichment is as follows. Hexavalent uranium is supplied from the water column into the sediment via pore water or with settling particles and reduced to tetravalent uranium which is incorporated into organic matter or carbonate fluoroapatite formed diagenetically (VEEH *et al.*, 1974; CALVERT and PRICE, 1983; YAMADA and TSUNOGAI, 1983/1984).

Vanadium is slightly concentrated in organic-rich reducing sediments such as Black Sea sediments (HIRST, 1974; VOLKOV and FOMINA, 1974), Saanich Inlet sediments (FRANCOIS, 1988)

and upwelling sediments from the Gulf of California (BRUMSACK, 1986). It is extremely enriched in ancient black shales from Atlantic Ocean (BRUMSACK, 1980) and the United States (VINE and TOURTELOT, 1970; LEVENTHAL and HOSTERMAN, 1982). Although the vanadium content is a little low in living plankton compared to average shale (KNAUSS and KU, 1983), most of vanadium in ancient sediments of marine origin are in the kerogen fraction and its chemical species is largely vanadyl porphyrin (PREMOVIC *et al.*, 1986). In reducing environments, vanadate anions are reduced to vanadyl cations ( $\text{VO}^{2+}$ ), which form stable complexes with organic chelates such as humic substances, and is strongly adsorbed on particles such as clays and oxides (WEHRLI and STUMM, 1989). Chromium is slightly enriched in organic-rich reducing sediments (BRONGERSMA-SANDERS *et al.*, 1980; FRANCOIS, 1988) and in black shales (VINE and TOURTELOT, 1970; BRUMSACK, 1980). Chromium supplied with biogenic particulates is reduced to  $\text{Cr}^{3+}$  in anoxic sediments, and  $\text{Cr}^{3+}$  is readily adsorbed and incorporated in the sediments (ELDERFIELD, 1970; FRANCOIS, 1988; SHAW *et al.*, 1990).

Iodine is much more concentrated in organic-rich oxidizing sediments than in organic-rich reducing sediments (PRICE and CALVERT, 1973, 1977). This is attributed to that iodine is concentrated in living plankton within the euphotic zone and taken up additionally by organic matter at the sediment-seawater interface under oxidizing conditions, where the concentration of total iodine in interstitial water is much higher than that in seawater (PRICE and CALVERT, 1977; HARVEY, 1980; KENNEDY and ELDERFIELD, 1987a). However, sorption of iodine on Mn and Fe oxyhydroxides is not ruled out (SUGAWARA *et al.*, 1958; ULLMAN and ALLER, 1985; KENNEDY and ELDERFIELD, 1987b). The enrichment of B in shales relative to the crustal rocks is due to its incorporation into clay minerals (WEDEPOHL, 1970).

Manganese is less concentrated in organic-rich reducing sediments than in normal shales. Manganese has a weak affinity for organic matter and sulfides, although it is sometimes enriched in reducing sediments as carbonates (MANHEIM, 1961; PEDERSEN and PRICE, 1982; JAKOBSEN

and POSTMA, 1989). Sodium, Mg, Ca, Sr and Cl are washed off from sediments after uplift above sea level or during weathering.

#### 4. The behavior of elements in marine environments

As the result of weathering of the crustal rocks, dissolved solids are supplied to the oceans by rivers, and solid products by rivers as suspended matter and through the atmosphere as eolian dust. The partitioning of elements between weathered silicate minerals and river water is controlled by the electrostatic interaction between elements and oxygen in silicate mineral lattices, and can be related to their electronegativity function ( $Q_{\text{MO}}$ ) (WHITFIELD and TURNER, 1979; MARTIN and WHITFIELD, 1983). Further, the concentration ratios of elements in river water to seawater show a linear relationship with their mean oceanic residence times (LI, 1982a). Suspended matter in river water and eolian dust have the chemical composition of average shale (LI, 1981b; MARTIN and WHITFIELD, 1983). These terrigenous aluminosilicates will suffer only a little alteration during settling through the water column and during diagenesis after deposition on the seafloor.

Dissolved elements in seawater are taken up by phytoplankton and removed from surface water as settling particles. They are divided into fecal pellets and large amorphous aggregates (marine snow), and composed of organic matter, biogenic calcium carbonate and opal (see FOWLER and KNAUER, 1986). The biogenic components of settling particles are partially regenerated during sinking through the water column and the fluxes decrease with depth. However, a mid-water increase of the fluxes has been observed and has been attributed to *in situ* repacking of suspended matter into fecal pellets by zooplankton (URRERE and KNAUER, 1981) or *in situ* production of new particulate organic carbon by bacterial chemolithotrophy (KARL *et al.*, 1984, 1988). Further, Fe and Mn depositing bacteria are present in settling particles and Fe-Mn oxides contribute to scavenging trace elements from seawater (COWEN and SILVER, 1984; COWEN and BRULAND, 1985; COWEN *et al.*, 1986). Aluminosilicate minerals of eolian origin

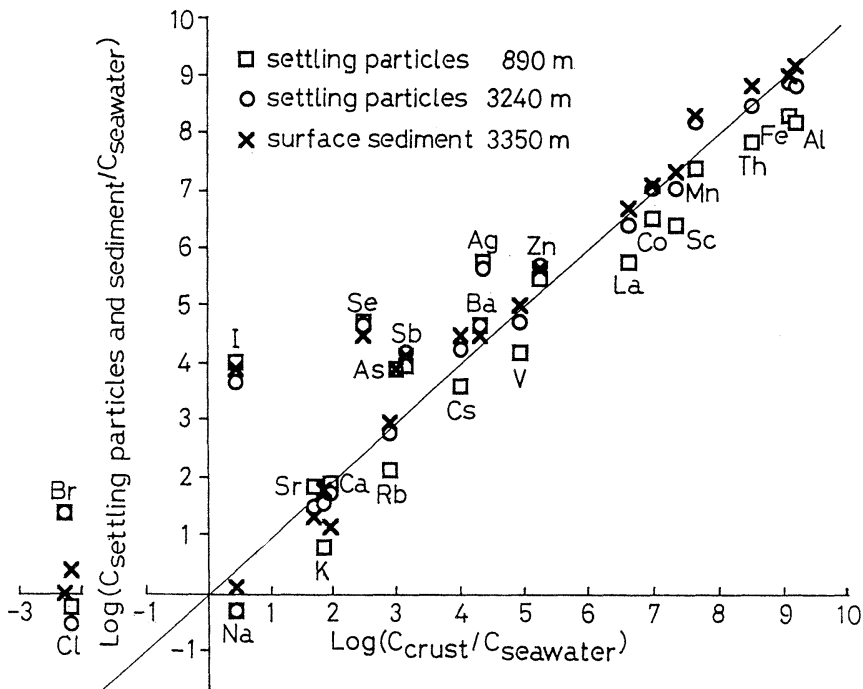

Fig. 6. Comparison between concentration ratios of elements in settling particles relative to seawater and those in the underlying surface sediment to seawater.

and transported laterally from continental slopes are entrapped by settling particles, and the flux of the lithogenous portion increases with depth (HONJO *et al.*, 1982a).

Settling particles on the sea-floor undergo early diagenesis mainly by the oxidation of organic matter (FROELICH *et al.*, 1979). Most of biogenic calcium carbonate and opal is dissolved during diagenesis. The composition of settling particles collected within a few hundred meters above the bottom is extremely different from that of the bottom surface sediment (HONJO *et al.*, 1982b; GARDNER *et al.*, 1985; WALSH *et al.*, 1988a, b). During diagenesis, the accompanying elements with settling particles are incorporated into sedimentary components and otherwise recycled into overlying bottom water as benthic fluxes.

A linear relationship is found between the mean oceanic residence time of elements and their concentration factors for marine organisms, which are concentration ratios of elements in marine organisms relative to seawater (YAMAMOTO, 1972; YAMAMOTO *et al.*, 1983; FISHER, 1986). FISHER (1986) explained the

relationship mainly by the interaction between metals and hydroxyl groups in biological systems. CHERRY *et al.* (1978) also found the linear relationship between the mean oceanic residence times of elements and their concentration factors for fecal pellets of zooplankton. However, the concentrations of elements in settling particles collected in sediment traps change with depth (BREWER *et al.*, 1980; ANDERSON, 1982; GARDNER *et al.*, 1985; MASUZAWA *et al.*, 1989).

In Fig. 6, the concentration ratios of elements in settling particles at two different depths and the underlying sediment from Japan Sea (MASUZAWA *et al.*, 1989) are plotted against those in the crustal rocks. The concentrations of elements enriched in oxidizing sediments (Mn, Fe, Co, Th, etc.) increase with depth, while those enriched in reducing sediments (As, Se, Sb, I, etc.) decrease slightly or change little. As the lithogenous fraction increases with depth. Brewer *et al.* (1980) divided elements into three groups on the basis of Me/Al ratios. Lithogenous components, whose Me/Al ratios are constant with depth, involve Al, Ti, V, K, La, <sup>232</sup>Th, etc. Biogenic components, whose Me/Al

ratios decrease with depth, involve Ca, Sr, Ba,  $^{226}\text{Ra}$ , Si, Br, I, As, Se, Sb, Ag, Cd, U, etc. Scavenged components, whose Me/Al ratios increase with depth, involve Mn, Fe, Co, Cu,  $^{230,234}\text{Th}$ , etc.

The concentrations of elements classified into biogenic components are higher in fecal pellets than in the crustal rocks (FOWLER, 1977). However, biogenic elements are not necessarily enriched in fecal pellets than scavenged elements with respect to their concentration factors (CHERRY *et al.*, 1978). The difference between the two groups is attributed to the fact that biogenic elements are less adsorbed on hydrogenous components such as *in situ* produced Fe-Mn oxides than scavenged elements. Arsenic, Se and Sb, which are present as oxyanions in oxygenated seawater, are usually reduced after uptake by organisms and transformed into organometalloid compounds (ANDRAE and KLUMP, 1979; WILLIAMS, 1981; WOOD and WANG, 1983). These organometalloid compounds in settling particles are regenerated to oxyanions during vertical transport in the water column (CUTTER and BRULAND, 1984). Oxyanions are less adsorbed on hydrogenous oxides than so-called scavenged elements, and have relatively long mean oceanic residence times (Fig. 1). On the other hand, scavenged elements in settling particles are also solubilized with the decomposition of biogenic components but adsorbed on *in situ* produced hydrogenous components. The concentrations of scavenged elements in settling particles increase with that of manganese, which is mostly present as oxides in settling particles (CHESTER and ASTON, 1976; JICKELLS *et al.*, 1984; COWEN and BRULAND, 1985; MASUZAWA *et al.*, 1989). In sediment traps, Fe-Mn oxides in settling particles are probably reduced to the readily leachable form during deployment (MARTIN and KNAUER, 1983, 1984).

The classification of elements according to their behavior in settling particles is sometimes inconsistent with that on the basis of their distribution in sediments. CHESTER and HUGHES (1967) developed a chemical technique to separate ferromanganese minerals, carbonate minerals and adsorbed trace elements from pelagic sediments using an acid-reducing agent. On the basis of the method, V, Cr and Fe are classified into the lithogenous category, and Mn, Co, Ni

and Cu into non-lithogenous (hydrogenous + biogenous) category (CHESTER and HUGHES, 1969; CHESTER and MESSIHA-HANNA, 1970; ELDERFIELD, 1972). This means that although non-lithogenous iron behaves as a scavenged element, most of iron in marine environments is incorporated in aluminosilicate minerals. TOYODA and MASUDA (1990) measured the concentrations of many elements in surface sediments along the longitude of 170° W and observed that Co, Ni, Cu, Y and La have concentration maxima around the equatorial area together with Mn, while V and Cr have almost constant concentrations along the entire profile. This means that La is a scavenged element in contrast with the classification from settling particles. However, it is difficult to classify elements into a certain group because some elements have intermediate characteristics. It is necessary to know the non-lithogenous portion of elements in the sediment for the calculation of their mean oceanic residence times if we use the mean oceanic residence times as the measure of reactivity. When the total accumulation rates of lithogenous elements such as Fe, V and Cr are used for calculation, their mean oceanic residence times are underestimated.

Any of the elements in settling particles except for lithogenous ones are more or less recycled at the sediment-water interface as the benthic fluxes (COBLER and DYMOND, 1980; DYMOND and LYLE, 1985; FISCHER *et al.*, 1986). The benthic fluxes of elements depend upon the supply rate and composition of settling particles, sediment redox conditions, bioturbation and other factors. In the area where the penetration of oxygen into the sediment is enough to oxidize organic matter accumulated via settling particles, oxic diagenesis occurs and the benthic fluxes of trace elements are relatively small, judged from their concentrations in interstitial water of the surface sediment (KLINKHAMMER *et al.*, 1982; SAWLAN and MURRAY, 1983). During diagenesis of settling particles, Fe-Mn oxides are formed and occur as coatings on sedimentary components, microneules dispersed in the sediment and ferromanganese nodules (CALVERT and PRICE, 1977; CALVERT *et al.*, 1978; KUNZENDORF *et al.*, 1989). Authigenic Fe-Mn oxides readily adsorb trace

elements released from settling particles, although the adsorption affinity is different from element to element as is evident from Fig. 1.

In the oxic-diagenetic environment such as DOMES Sites A, B and C, and MANOP Site S, the chemical composition of the leached fraction with an acid-reducing agent from the sediments (sediment oxyhydroxides) is similar to that of  $\delta$ -MnO<sub>2</sub>-rich nodules (CHESTER *et al.*, 1973; PIPER *et al.*, 1979; APLIN and CRONAN, 1985; PIPER *et al.*, 1987). Further, the composition of micronodules in the sediments is similar to that of associated macronodules (SUGISAKI *et al.*, 1987; KUNZENDORF *et al.*, 1989). The aluminosilicate fraction after leaching has the chemical composition similar to average shale (PIPER *et al.*, 1979; PIPER, 1988).

In the suboxic diagenetic regions such as MANOP Sites H and M where the flux of organic carbon is more than that in the oxic diagenetic regions, cationic transition metal contents in the surface sediments are rather higher than those from the oxic diagenetic regions because manganese and iron, which are remobilized from the suboxic deeper layer, are precipitated as oxides in the oxic surface layer (GRAYBEAL and HEATH, 1984; LYLE *et al.*, 1984). However, cationic transition metal contents in manganese nodules from the suboxic diagenetic regions are lower than those from the oxic diagenetic regions (DYMOND *et al.*, 1984). A partial decoupling of the sediment-nodule system can be explained by the non-steady-state model for the formation of suboxic diagenetic manganese nodules (TAKEMATSU *et al.*, 1989). Calcareous oozes in suboxic diagenetic regions have the chemical composition similar to suboxic diagenetic siliceous sediments on a carbonate-free basis, and therefore carbonates are only a diluent (STOFFERS *et al.*, 1981).

In deep-sea regions where the flux of biogenic components is small and continentally derived aluminosilicates are the major components, red clay occurs, whose non-lithogenous components are directly from seawater. Cationic transition metal contents in red clay are almost constant with depth (EL-WAKEEL and RILEY, 1961; CHESTER and HUGHES, 1969), and are generally low relative to those in the oxic and suboxic diagenetic surface sediments. The ratios of Ce

/La and Co/Mn are the good indicators of the different sediment types. The order of their ratios is red clay > oxic diagenetic sediments > suboxic diagenetic sediments (GLASBY *et al.*, 1987; PIPER *et al.*, 1988; KUNZENDORF *et al.*, 1989).

In hydrothermal areas, metalliferous sediments occur and have high contents of cationic transition metals, especially of Fe, on a carbonate-free basis (BOSTROM and PETERSON, 1969; DYMOND *et al.*, 1977; HEATH and DYMOND, 1977, 1981; DYMOND, 1981; MARCHIG and GUNDLACH, 1982; SHEARME *et al.*, 1983; BACKER *et al.*, 1985; MARCHIG *et al.*, 1985; STOFFERS *et al.*, 1985; BARRETT *et al.*, 1987). However, the contents of minor cationic transition metals in metalliferous sediments are rather low relative to those in pelagic clays when their contents are normalized to non-lithogenous Fe and Mn oxides. Buoyant hydrothermal emanations containing particulate Fe and dissolved Mn trail several hundred meters above the sea-floor and are advected away from vent fields (KLINKHAMMER and HUDSON, 1986; KLINKHAMMER *et al.*, 1986). Fe and Mn oxides of hydrothermal origin scavenge minor elements from seawater together with settling particles and settle on the sea-floor (TROCINE and TREFRY, 1988; FEELY *et al.*, 1990). The validity of this scenario is evident from the fact that hydrothermal sediments have the negative Ce anomaly which is the reflection of rapid scavenging of REE from seawater by hydrothermal Mn-Fe oxides as well as biogenous carbonates (RUHLIN and OWEN, 1986).

Hydrothermal massive sulfides of Fe, Zn and Cu are almost free of Ni, reflecting the composition of hydrothermal fluids (BISCHOFF *et al.*, 1983; BOWERS *et al.*, 1985; RONA *et al.*, 1986). However, even suspended particles in black smoke within 20m above hydrothermal vents contain 20–220 ppm of Ni (MOTTL and MCCONACHY, 1990) in spite that hydrothermal fluids contain little Ni (VON DAMM *et al.*, 1985). The content of Ni in metalliferous sediments on the crest of the East Pacific Rise (ERR) is rather low relative to that on the flanks of EPR (BOSTROM and PETERSON, 1969). This phenomenon is attributed to the scavenging of minor transition elements from seawater by hydro-

thermal Fe-Mn oxides or sulfides (RUHLIN and OWEN, 1986; METZ *et al.*, 1988; TROCINE and TREFRY, 1988). Therefore, the concentration ratio of Cu to Ni in sediments can be used as a measure of hydrothermal influence. Metalliferous sediments in which the contents of Cu and Zn are much higher than that of Ni are restricted to the proximity of hydrothermal vent fields (DYMOND *et al.*, 1977; HEATH and DYMOND, 1977; SHEARME *et al.*, 1983; BARRETT *et al.*, 1987; METZ *et al.*, 1988).

The chemical composition of EPR crest sediments is equivalent to that of micronodules in them within a factor of two with respect to Mn, Fe, Co, Ni, Cu and Zn (STOFFERS *et al.*, 1985). The micronodules have the chemical composition similar to that of hydrothermal manganese crusts. Hydrothermal manganese crusts have more than an order of magnitude lower contents of cationic transition metals (Co, Ni, Cu, Zn, etc.) relative to and oxyanionic element contents comparable to the nodules of other origins (CORLISS *et al.*, 1978; LALOU *et al.*, 1983; MOORBY and CRONAN, 1983; RONA *et al.*, 1984; THOMPSON *et al.*, 1985; TAKEMATSU *et al.*, 1989, 1990), although their chemical composition is highly variable. The low contents of cationic transition metals in hydrothermal manganese crusts are attributed to insufficient scavenging by rapid growth of crusts (EDMOND *et al.*, 1979). As described before, the enrichment of cationic transition metals in manganese nodules is due to lattice substitution after adsorption, and that of oxyanionic elements only to adsorption (TAKEMATSU, 1987). It takes long time for the incorporation of cationic transition metals into manganese nodules.

This is the reason why cationic transition metals are depleted and oxyanionic elements are enriched in rapidly growing hydrothermal manganese crusts (MOORBY and CRONAN, 1983; MOORBY *et al.*, 1984; TAKEMATSU *et al.*, 1990). Therefore, the contents of cationic transition metals in metalliferous sediments increase with the distance from mid-ocean ridges, when their contents are normalized to those of non-lithogenous iron and manganese oxides, as is evident from the sediments of the East Pacific Rise-Tahiti transect (STOFFERS *et al.*, 1985). In the case of the Bauer Deep sediments, Fe and Mn

are of hydrothermal origin and the other minor elements are mainly from seawater (DYMOND, 1981). This is because the concentrations of Fe and Mn in hydrothermal fluids are ca.  $10^6$  times higher than those in deep seawater, those of Co, Cu and Zn are ca.  $10^4$  times, and Ni is less than 10 times (BRULAND, 1983; VON DAMM *et al.*, 1985). The sediments from the Bauer Basin have the minor element composition similar to those from EPR-Tahiti transect when the contents of manganese and iron oxides are similar (HEATH and DYMOND, 1981; STOFFERS *et al.*, 1985).

In brief, the chemical composition of oxic deep-sea sediments is expressed as admixtures of aluminosilicate minerals with average shale composition and ferromanganese oxides with the end-member compositions of different origins (hydrogenous, oxic diagenetic, suboxic diagenetic and hydrothermal), although metalliferous sediments contain Al-poor Fe-smectite, of which minor transition metal contents are lower than those of average shale (MOORBY and CRONAN, 1983; RONA *et al.*, 1984).

In the more reducing environments such as continental margins, concentrations of transition metals such as Mn, Co, Ni, Cu and even Fe are high in interstitial water and these elements are released from the sediments as the benthic fluxes (SAWLAN and MURRAY, 1983; HEGGIE *et al.*, 1987; JOHNSON *et al.*, 1988; SHAW *et al.*, 1990). Therefore, the chemical composition of mildly reducing continental margin sediments is similar to that of average shale (WEDEPOHL, 1960; CHESTER and MESSIHA-HANNA, 1970; ELDERFIELD, 1972). Cationic transition elements released from reduced continental margin sediments are transported laterally to the central parts of the ocean through oxygen minima (KLINKHAMMER and BENDER, 1980; MARTIN and KNAUER, 1984; MARTIN *et al.*, 1985). However, the behavior of oxyanionic elements such as V, Cr and Mo to redox conditions is in contrast to that of cationic transition metals such as Mn, Ni and Co. According to SHAW *et al.* (1990), in suboxic diagenetic sediments (The Patton Escarpment), concentrations of V, Cr and Mo in interstitial water of the oxidizing surface layer where Mn-oxides are present are high, while those of Mn, Ni and Co are extremely low. High concentrations of oxyanionic

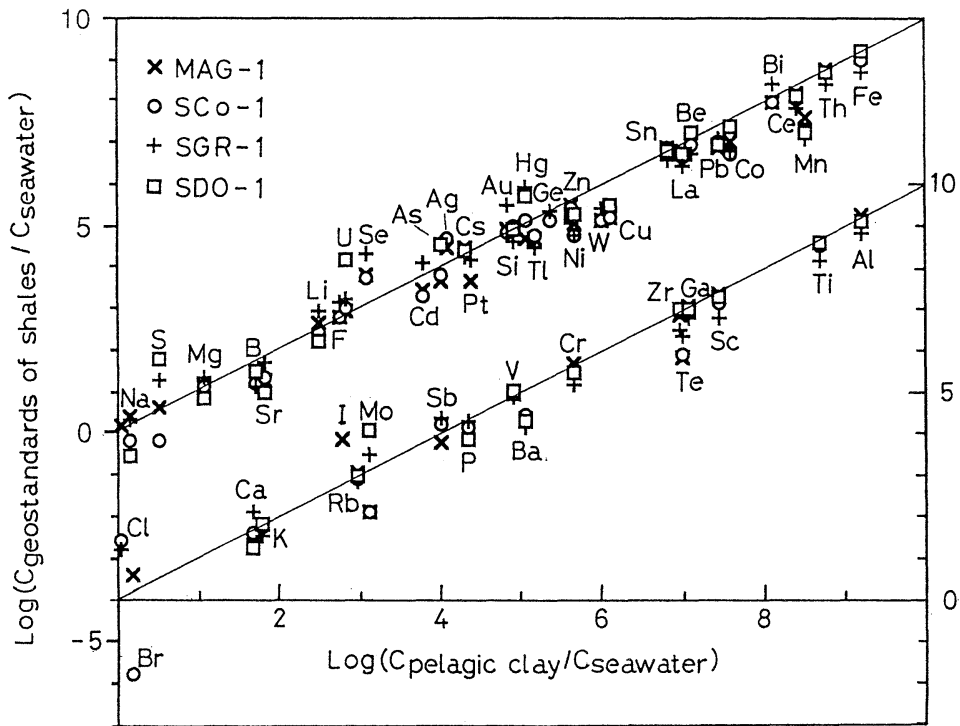

Fig. 7. Comparison between concentration ratios of elements in reducing shales relative to seawater and those in oxidizing pelagic clay to seawater. To avoid overlapping, elements are arbitrarily divided into two parts.

elements in the oxidizing interstitial water are the result of the adsorption affinity of these oxyanions on oxides which is weaker than that of cationic transition metals as is evident from Fig. 1. On the other hand, in more reducing sediments of the California Borderland, concentrations of cationic transition metals in interstitial water are high, while those of oxyanionic elements decrease as conditions become more reducing. The oxyanions are transformed to their reduced species and incorporated into the sediments. The contents of V, Cr and Mo are high in the most reducing sediments investigated, although high contents of Mo are also observed in the most oxidizing Mn-rich sediment. Such contrasting behavior of cationic transition metals and oxyanionic elements is also observed in a core from the Panama Basin (BONATTI *et al.*, 1971). Manganese, Co and Ni are concentrated in the oxidizing surface layer, while Cr and V are enriched in the reducing deeper layer.

In anoxic regions, many minor elements are

retained in the sediments, except for Mn, as is described before. In Fig. 7, the contents of elements in Geostandards of a near shore sediment and reducing shales are compared with those of pelagic clay with respect to their concentration ratios to seawater. The elements which are concentrated in reducing sediments are S, Fe, As, Se, Mo, Ag, Cd, Sb, I, Au, Hg, Bi, U and probably Te, while those concentrated in oxidizing sediments are Mn, Fe, Co, Ni, Cu, Mo, Ce, Te, W, Tl, Pb, Bi, and probably Zn, Cd, La, Pt and Th. Iron, Mo, Bi, and probably Cd and Te are concentrated in both reducing and oxidizing sediments. Beryllium, B, Al, Si, Sc, Ti, V, Cr, Ga, Ge and Zr are evenly distributed and classified as the lithogenous elements. Alkali and alkaline-earth metals such as Li, Na, Mg, K, Rb and Cs have no fractionation between reducing and oxidizing sediments. The contents of Ca, Sr and Ba are dependent on primarily productivity in overlying water and water depth.



## 5. Summary and conclusions

a) Elements are supplied from land to the sea in dissolved and particulate states as the result of weathering of crustal rocks. Particulate elements are transported through the atmosphere as airborne dusts and by rivers as suspended matter. Airborne dusts and suspended matter in river water undergo desorption and adsorption of elements in contact with seawater, but principally keep their original composition during sinking through the water column and during diagenesis after deposition on the sea-floor. They generally have the chemical composition of average shale. Some elements (Be, Al, K, Ti, V, Cr, Ga, Zr, etc.) are recycled mainly with weathered aluminosilicates, and others mainly through the dissolved state in seawater. The proportion of dissolved to particulate differs with each elements.

b) Dissolved elements in seawater are taken up by phytoplankton and transported to the sea-floor as settling particles. Settling particles in surface water are composed of biogenous calcium carbonate, opal, organic matter and terrigenous aluminosilicates. Biogenous components in settling particles are regenerated during sinking through the water column and the proportion of the lithogenous fraction increases with depth. Below the oxygen minimum layer, Fe-Mn oxides are precipitated on settling particles by microbial mediation and play an important role in scavenging minor elements from seawater. The elements classified as "scavenged" are those which are readily taken up by Fe-Mn oxides. On the other hand, the elements classified as "biogenous" are those which have biogenous insoluble compounds (Si, Ca, Sr and Ba) and oxyanions (As, Se, Sb, I, etc.) which are reductively taken up by phytoplankton and less adsorbed on Fe-Mn oxides than cationic "scavenged" elements.

c) On the basis of redox potential which is regulated by the amount of organic matter supplied to the sea-floor via settling particles, marine sediments are divided into oxic deep-sea sediments, intermediate near-shore sediments and anoxic sediments. The chemical composition of oxic sediments can be simulated by a mixture of aluminosilicates with average shale composition and Fe-Mn oxides with the

composition of associated ferromanganese nodules. Hydrogenous Fe-Mn oxides occur as coatings on sedimentary components and micronodules dispersed in the sediment. The incorporation mechanism of elements into oxides is primarily the adsorption of elements on hydrolyzed oxides. However, cationic elements can be incorporated into oxides through their lattice substitution for oxide-forming metals during the oxide growth. Therefore, the distribution coefficients of cationic elements for Fe-Mn oxides, except for alkali and alkaline-earth metals, are generally larger than those of oxyanionic elements. The chemical composition of Fe-Mn oxides in the sediment and associated ferromanganese nodules is controlled by the supply rate of settling particles and hydrothermal activities. Oxic deep-sea sediments are divided into red clay, oxic diagenetic sediments and suboxic diagenetic sediments on the basis of the flux of settling particles. The contents of cationic transition elements are in the order: suboxic diagenetic sediments > oxic diagenetic sediments > red clay. It must be noted that in suboxic diagenetic sediments, a partial decoupling occurs between Fe-Mn oxides in the sediments and associated ferromanganese nodules, and that the contents of cationic transition elements in the former are higher than those in the latter. Calcium carbonates act as a diluent because the contents of minor elements in them are extremely low. In accordance with this, the contents of minor elements in deep-sea sediments are generally discussed on a carbonate-free basis.

d) In hydrothermal regions, so-called metalliferous sediments occur and have extremely high contents of Fe and Mn. Iron and manganese oxides in metalliferous sediments are of hydrothermal origin but other minor associated elements are from seawater. The contents of cationic minor elements in hydrothermal ferromanganese nodules are low on account of their inefficient lattice substitution in the rapidly forming oxides, while those of oxyanionic elements are comparable to those in nodules of other origins, because of the rapidity of their adsorption. Therefore, the contents of cationic minor elements in metalliferous sediments are low when they are normalized to non-litho-

genous Fe-Mn oxides.

e) Hydrothermal sulfides of Fe, Zn and Cu which are almost free of Ni and metalliferous sediments in which contents of Cu and Zn are much higher than that of Ni are restricted to the proximity of hydrothermal vent fields. With the distance from the mid-ocean ridges, the minor element composition of metalliferous sediments approaches gradually to that of ordinary pelagic sediments with respect to Mn-Fe oxides, because most parts of minor elements are scavenged from seawater by hydrothermal Mn-Fe oxides.

f) In mildly reducing or seasonally oxidizing near-shore sediments, neither manganese oxides nor iron sulfides are formed during early diagenesis, and the contents of cationic minor elements are much low relative to oxic deep-sea sediments. Elements transported by settling particles are released during early diagenesis from the sediments as benthic fluxes and conveyed to deep waters by advection through the oxygen minimum layer. The remains are similar to average shale in the chemical composition. Exceptions to this are Se and U. They are reduced and fixed in the sediments.

g) In anoxic environments where iron sulfides are formed by microbial reduction of sulfate, chalcophile elements are enriched in the sediments.

h) Partition coefficients of elements between aluminosilicates and river water (during weathering) and those between phytoplankton and seawater have some correlations with the mean oceanic residence times of elements. However, partitioning of elements between oxygen-dominated minerals and seawater (during reverse weathering) play a major role in controlling their mean oceanic residence times, because Mn-Fe oxides and biogenous silica as well as authigenic aluminosilicates are the major products for removal of dissolved elements in oxidizing marine environments. Anoxic sediments have high contents of elements which are enriched in shales relative to the crustal rocks (As, Se, Br, Mo, Cd, Sb, I, Hg, Bi and U). However, anoxic sediments will make little, if any, contribution to the control of the mean oceanic residence times of elements, because these sediments are restricted within

narrow limits.

### Acknowledgments

The author would like to thank Prof. Y. —H. Li, University of Hawaii, Dr. Y. KANAI, Geological Survey of Japan and Prof. M. KATADA, Iwate University, for valuable information.

### References

- ANDERSON R. F. (1982): Concentration, vertical flux, and remineralization of particulate uranium in seawater. *Geochim. Cosmochim. Acta*, **46**, 1293-1299.
- ANDREAE, M. O. and D. KLUMP (1979): Biosynthesis and release of organoarsenic compounds by marine algae. *Environ. Sci. Technol.*, **13**, 738-741.
- APLIN, A. C. and D. S. CRONAN (1985): Ferromanganese oxide deposits from the Central Pacific Ocean, II. Nodules and associated sediments. *Geochim. Cosmochim. Acta*, **49**, 437-451.
- BACKER, H., J. LANGE and V. MARCHIG (1985): Hydrothermal activity and sulfide formation in axial valleys of the East Pacific Rise crest between 18 and 22°S. *Earth Planet. Sci. Lett.*, **72**, 9-22.
- BALISTRERI, L. S. and T. T. CHAO (1987): Selenium adsorption by goethite. *Soil Sci. Soc. Am. J.*, **51**, 1145-1151.
- BALISTRERI, L., P. G. BREWER and J. W. MURRAY (1981): Scavenging residence times of trace metals and surface chemistry of sinking particles in the deep ocean. *Deep-Sea Res.*, **28A**, 101-121.
- BARRETT, T. J., P. N. TAYLOR and J. LUGOWSKI (1987): Metalliferous sediments from DSDP Leg 92: The East Pacific Rise transect. *Geochim. Cosmochim. Acta*, **51**, 2241-2253.
- BATURIN, G. N. (1988): *The Geochemistry of Manganese and Manganese Nodules in the Ocean*. D. Reidel Publishing Company, Dordrecht, 342 pp.
- BELZILE, N. and J. LEBEL (1986): Capture of arsenic by pyrite in near-shore marine sediments. *Chem. Geol.*, **54**, 279-281.
- BERTINE, K. K. (1972): The deposition of molybdenum in anoxic waters. *Mar. Chem.*, **1**, 43-53.
- BISCHOFF, J. L., D. Z. PIPER and K. LEONG (1981): The aluminosilicate fraction of North Pacific manganese nodules. *Geochim. Cosmochim. Acta*, **45**, 2047-2063.
- BISCHOFF, J. L., R. J. ROSENBAUER, P. J. ARUSCAVAGE, P. A. BAEDCKER and J. G. CROCK

- (1983): Sea-floor massive sulfide deposits from 21°N, East Pacific Rise; Juan de Fuca Ridge; and Galapagos Rift: Bulk chemical composition and economic implications. *Econ. Geol.*, **78**, 1711-1720.
- BONATTI, E., D. E. FISHER, O. JOENSUU and H. S. RYDELL (1971): Postdepositional mobility of some transition elements, phosphorus, uranium and thorium in deep sea sediments. *Geochim. Cosmochim. Acta*, **35**, 189-201.
- BOSTRÖM, K. and M. N. A. PETERSON (1969): The origin of aluminum-poor ferromanganous sediments in areas of high heat flow on the East Pacific Rise. *Mar. Geol.*, **7**, 427-447.
- BOSTRÖM, K., O. JOENSUU, C. MOORE, B. BOSTRÖM, M. DALZIEL and A. HOROWITZ (1973): Geochemistry of barium in pelagic sediments. *Lithos*, **6**, 159-174.
- BOWERS, T. S., K. L. VON DAMM and J. M. EDMOND (1985): Chemical evolution of mid-ocean ridge hot springs. *Geochim. Cosmochim. Acta*, **49**, 2239-2252.
- BREWER, P. G., Y. NOZAKI, D. W. SPENCER and A. P. FLEER (1980): Sediment trap experiments in the deep North Atlantic: isotopic and elemental fluxes. *J. Mar. Res.*, **38**, 703-728.
- BRONGERSMA-SANDERS, M., K.M. STEPHAN, T.G. KWEE and M. DE BRUIN (1980): Distribution of minor elements in cores from the Southwest Africa shelf with notes on plankton and fish mortality. *Mar. Geol.*, **37**, 91-132.
- BRULAND, K.W. (1983): Trace elements in seawater. p. 157-220. *In* J. P. Riley and R. Chester (eds.), *Chemical Oceanography*, Vol. 8. Academic Press, London.
- BRUMSACK, H. J. (1980): Geochemistry of Cretaceous black shales from the Atlantic Ocean (DSDP Legs 11, 14, 36, and 41). *Chem. Geol.*, **31**, 1-25.
- BRUMSACK, H. J. (1986): The inorganic geochemistry of Cretaceous black shales (DSDP Leg 41) in comparison to modern upwelling sediments from the Gulf of California. p. 447-462. *In* C.P. SUMMERHAYES and N. J. SHACKLETON (eds.), *North Atlantic Paleooceanography*. *Geol. Soc. Sp. Bull. No. 21*.
- BRUMSACK, H. J. and J.M. GIESKES (1983): Interstitial water trace-metal chemistry of laminated sediments from the Gulf of California, Mexico. *Mar. Chem.*, **14**, 89-106.
- BURNS, R.G. and V.M. BURNS (1977): Mineralogy. p. 185-248. *In* G.P. GLASBY (ed.), *Marine Manganese Deposits*. Elsevier, Amsterdam.
- BURNS, R. G., V. M. BURNS and H. W. STOCKMAN (1983): A review of the todorokite-buserite problem: implications to the mineralogy of marine manganese nodules. *Am. Mineral.*, **68**, 972-980.
- CALVERT, S. E. and N. B. PRICE (1977): Geochemical variation in ferromanganese nodules and associated sediments from the Pacific Ocean. *Mar. Chem.*, **5**, 43-74.
- CALVERT, S. E. and N. B. PRICE (1983): Geochemistry of Namibian shelf sediments. p. 337-376. *In* E. SUESS and J. THIEDE (eds.), *Coastal Upwelling*, Plenum Press, New York and London.
- CALVERT, S. E., N. B. PRICE, G. R. HEATH and T. C. MOORE, Jr. (1978): Relationship between ferromanganese nodule compositions and sedimentation in a small survey area of the equatorial Pacific. *J. Mar. Res.*, **36**, 161-183.
- CHERRY, R. D., J. J. W. HIGGO and S. W. FOWLER (1978): Zooplankton fecal pellets and element residence times in the ocean. *Nature*, **274**, 246-248.
- CHESTER, R. and M. J. HUGHES (1967): A chemical technique for separation of ferromanganese minerals, carbonate minerals and adsorbed trace elements from pelagic sediments. *Chem. Geol.*, **2**, 249-262.
- CHESTER, R. and M. J. HUGHES (1969): The trace element geochemistry of a North Pacific pelagic clay core. *Deep-Sea Res.*, **16**, 639-654.
- CHESTER, R. and R. G. MESSIHA-HANNA (1970): Trace element partition patterns in North Atlantic deep-sea sediments. *Geochim. Cosmochim. Acta*, **34**, 1121-1128.
- CHESTER, R. and S. R. ASTON (1976): The geochemistry of deep-sea sediments. p. 281-390. *In* J. P. RILEY and R. CHESTER (eds.), *Chemical Oceanography*, Vol. 6. Academic Press, London.
- CHESTER, R., L.R. JOHNSON, R. G. MESSIHA-HANNA and R.C. PADGHAM (1973): Similarities between Mn, Ni and Co contents of deep-sea clays and manganese nodules from the southwest region of the North Atlantic. *Mar. Geol.*, **14**, M15-M20.
- COBLER, R. and J. DYMOND (1980): Sediment trap experiment on the Galapagos spreading center, equatorial Pacific. *Science*, **209**, 801-803.
- CORLISS, J. B., M. LYLE, J. DYMOND and K. CRANE (1978): The geochemistry of hydrothermal mounds near the Galapagos rift. *Earth Planet. Sci. Lett.*, **40**, 12-24.
- COWEN, J. P. and M. W. SILVER (1984): The association of iron and manganese with bacteria on marine macroparticulate material. *Science*, **224**, 1340-1342.

- COWEN, J. P. and K. W. BRULAND (1985): Metal deposits associated with bacteria: implications for Fe and Mn marine biochemistry. *Deep-Sea Res.*, **32**, 253-272.
- COWEN, J. P., G. J. MASSOTH and E. T. BAKER (1986): Bacterial scavenging of Mn and Fe in a mid-to far-field hydrothermal particle plume. *Nature*, **322**, 169-171.
- CUTTER, G. A. (1985): Determination of selenium speciation in biologic particles and sediments. *Anal. Chem.*, **57**, 2951-2955.
- CUTTER, G. A. and K. W. BRULAND (1984): The marine biochemistry of selenium: A re-evaluation. *Limnol. Oceanogr.*, **29**, 1179-1192.
- DEHAIRS, F., R. CHESSELET and J. JEDWAB (1980): Discrete suspended particles of barite and the barium cycle in the open ocean. *Earth Planet. Sci. Lett.*, **49**, 528-550.
- DYMOND, J. (1981): Geochemistry of Nazca plate surface sediments: An evaluation of hydrothermal, biogenic, detrital and hydrogenous sources. *Geol. Soc. Amer. Mem.*, **154**, 133-173.
- DYMOND, J. and M. LYLE (1985): Flux comparisons between sediments and sediment traps in the eastern tropical Pacific: Implications for atmospheric CO<sub>2</sub> variations during the Pleistocene. *Limnol. Oceanogr.*, **30**, 699-712.
- DYMOND, J., J. B. CORLISS and G. R. HEATH (1977): History of metalliferous sedimentation at Deep-Sea Drilling Site 319 in the South Eastern Pacific. *Geochim. Cosmochim. Acta*, **41**, 741-753.
- DYMOND, J., D. Z. PIPER, M. LYLE, B. FINNEY, K. MURPHY, R. CONARD and N. PISIAS (1984): Ferromanganese nodules from MANOP Site H. Control of mineralogical and chemical composition by multiple accretionary processes. *Geochim. Cosmochim. Acta*, **48**, 931-950.
- EDENBORN, H. M., N. BELZILE, A. MUCCI, J. LEVEL and N. SILVERBERG (1986): Observations on the diagenetic behavior of arsenic in a deep coastal sediment. *Biogeochemistry*, **2**, 359-376.
- EDMOND, J. M., C. MEASURES, B. MANGUM, B. GRANT, F. R. SCLATER, R. COLLIER, A. HUDSON, L. I. GORDON and J. B. CORLISS (1979): On the formation of metal-rich deposits at ridge crests. *Earth Planet. Sci. Lett.*, **46**, 19-30.
- ELDERFIELD, H. (1970): Chromium speciation in sea water. *Earth Planet. Sci. Lett.*, **9**, 10-16.
- ELDERFIELD, H. (1972): Compositional variations in the manganese oxide component of marine sediments. *Nature*, **237**, 110-112.
- EL WAKEEL, S. K. and J. P. RILEY (1961): Chemical and mineralogical studies of deep-sea sediments. *Geochim. Cosmochim. Acta*, **25**, 110-146.
- FEELY, R. A., G. J. MASSOTH, E. T. BAKER, J. P. COWEN, M. F. LAMB and K. A. KROGSLUND (1990): The effect of hydrothermal processes on midwater phosphorus distributions in the northeast Pacific. *Earth Planet. Sci. Lett.*, **96**, 305-318.
- FISCHER, K., J. DYMOND, M. LYLE, A. SOUTAR and S. RAU (1986): The benthic cycle of copper: Evidence from sediment trap experiments in the eastern tropical North Pacific Ocean. *Geochim. Cosmochim. Acta*, **50**, 1535-1543.
- FISHER, N. S. (1986): On the reactivity of metals for marine phytoplankton. *Limnol. Oceanogr.*, **31**, 443-449.
- FOWLER, S. W. (1977): Trace elements in zooplankton particulate products. *Nature*, **269**, 51-53.
- FOWLER, S. W. and G. A. KNAUER (1986): Role of large particles in the transport of elements and organic compounds through the oceanic water column. *Prog. Oceanogr.*, **16**, 147-194.
- FRANCOIS, R. (1988): A study on the regulation of the concentrations of some trace metals (Rb, Sr, Zn, Pb, Cu, V, Cr, Ni, Mn and Mo) in Saanich Inlet, British Columbia, Canada. *Mar. Geol.*, **83**, 285-308.
- FROELICH, P. N. Jr. and M. O. ANDREAE (1981): The marine geochemistry of germanium: Ekasilicon. *Science*, **213**, 205-207.
- FROELICH, P. N., G. P. KLINKHAMMER, M. L. BENDER, N. A. LUEDKE, G. R. HEATH, D. CULLEN, P. DAUPHIN, D. HAMMOND, B. HARTMAN and V. MAYNARD (1979): Early oxidation of organic matter in pelagic sediments of the eastern equatorial Atlantic: suboxic diagenesis. *Geochim. Cosmochim. Acta*, **43**, 1075-1090.
- GARDNER, W. D., J. B. SOUTHARD and C. D. HOLLI-STER (1985): Sedimentation, resuspension and chemistry of particles in the northwest Atlantic. *Mar. Geol.*, **65**, 199-242.
- GILMOUR, I. and E. ANDERS (1989): Cretaceous-Tertiary boundary event: Evidence for a short time scale. *Geochim. Cosmochim. Acta*, **53**, 503-511.
- GLASBY, G. P. (1975): Minor element enrichment in manganese nodules relative to seawater and marine sediments. *Naturwissenschaften*, **62**, 133-135.
- GLASBY, G. P., R. GWOZDZ, H. KUNZENDORF, G. FRIEDRICH and T. THIJSEN (1987): The distribution on rare earth and minor elements in manganese nodules and sediments from the equatorial and S.W. Pacific. *Lithos*, **20**, 97-113.

- GOLDBERG, E. D. (1965): Minor elements in sea water. p. 163-196. *In* J. P. RILEY and G. SKIRROW (eds.), *Chemical Oceanography*, Vol. 1. Academic Press, London and New York.
- GOLDBERG, E. D. (1987): Comparative chemistry of the platinum and other heavy metals in the marine environment. *Pure & Appl. Chem.*, **59**, 565-571.
- GOLDBERG, S. and R. A. GLAUBIG (1985): Boron adsorption on aluminum and iron oxide minerals. *Soil Sci. Soc. Am. J.*, **49**, 1374-1379.
- GOVINDARAJU, K. (1989): 1989 compilation of working values and sample description for 272 geostandards. *Geostandards Newsletter*, **13**, 1-113.
- GRAYBEAL, A. L. and G. R. HEATH (1984): Remobilization of transition metals in surficial pelagic sediments from the eastern Pacific. *Geochim. Cosmochim. Acta*, **48**, 965-975.
- HARVEY, G. R. (1980): A Study of the chemistry of iodine and bromine in marine sediments. *Mar. Chem.*, **8**, 327-332.
- HEATH, G. R. and J. DYMOND (1977): Genesis and transformation of metalliferous sediments from the East Pacific Rise, Bauer Deep and Central Basin, northwest Nazca plate. *Geol. Soc. Amer. Bull.*, **88**, 723-733.
- HEATH, G. R. and J. DYMOND (1981): Metalliferous sediment deposition in time and space: East Pacific Rise and Bauer Basin, northern Nazca plate. *Geol. Soc. Amer. Mem.*, **154**, 175-197.
- HEGGIE, D., G. KLINKHAMMER and D. CULLEN (1987): Manganese and copper fluxes from continental margin sediments. *Geochim. Cosmochim. Acta*, **51**, 1059-1070.
- HIRST, D. M. (1974): Geochemistry of sediments from eleven Black Sea cores. p. 430-455. *In* E. T. DEGENS and D. A. ROSS (eds.), *The Black Sea Geology, Chemistry and Biology*. Am. Assoc. Pet. Geol. Mem., 20.
- HONJO, S., S. J. MANGANINI and L. J. POPPE (1982a): Sedimentation of lithogenic particles in the deep ocean. *Mar. Geol.*, **50**, 199-220.
- HONJO, S., S. J. MANGANINI and J. J. COLE (1982b): Sedimentation of biogenic matter in the deep ocean. *Deep-Sea Res.*, **29**, 609-625.
- HOWARD, J. H. III (1977): Geochemistry of selenium: formation of ferroselite and selenium behavior in the vicinity of oxidizing sulfide and uranium deposits. *Geochim. Cosmochim. Acta*, **41**, 1665-1678.
- JACOBS, L., E. EMERSON and S. S. HUESTED (1987): Trace metal geochemistry in the Cariaco Trench. *Deep-Sea Res.*, **34**, 965-981.
- JAKOBSEN, R. and D. POSTMA (1989): Formation and solid solution behavior of Ca-rhodochrosites in marine muds of the Baltic deeps. *Geochim. Cosmochim. Acta*, **53**, 2639-2648.
- JICKELLS, T. D., W. G. DEUSER and A. H. KNAP (1984): The sedimentation rates of trace elements in the Sargasso Sea measured by sediment trap. *Deep-Sea Res.*, **31**, 1169-1178.
- JOHNSON, K. S., P. M. STOUT, W. M. BERELSON and C. M. SAKAMOTO-ARNOLD (1988): Cobalt and copper distributions in the waters of Santa Monica Basin, California. *Nature*, **332**, 527-530.
- KARL, D. M., G. A. KNAUER and J. H. MARTIN (1988): Downward flux of particulate organic matter in the ocean: a particle decomposition paradox. *Nature*, **332**, 438-441.
- KARL, D. M., G. A. KNAUER, J. H. MARTIN and B. B. WARD (1984): Bacterial chemolithotrophy in the ocean is associated with sinking particles. *Nature*, **309**, 54-56.
- KEITH, M. L. (1982): Violent volcanism, stagnant oceans and some inferences regarding petroleum, strata-bound ores and mass extinctions. *Geochim. Cosmochim. Acta*, **46**, 2621-2637.
- KENNEDY, H. A. and H. ELDERFIELD (1987a): Iodine diagenesis in pelagic deep-sea sediments. *Geochim. Cosmochim. Acta*, **51**, 2489-2504.
- KENNEDY, H. A. and H. ELDERFIELD (1987b): Iodine diagenesis in non-pelagic deep-sea sediments. *Geochim. Cosmochim. Acta*, **51**, 2505-2514.
- KLINKHAMMER, G. P. and M. L. BENDER (1980): The distribution of manganese in the Pacific Ocean. *Earth Planet. Sci. Lett.*, **46**, 361-384.
- KLINKHAMMER, G. and A. HUDSON (1986): Dispersal patterns for hydrothermal plumes in the South Pacific using manganese as a tracer. *Earth Planet. Sci. Lett.*, **79**, 241-249.
- KLINKHAMMER, G., D. T. HEGGIE and D. W. GRAHAM (1982): Metal diagenesis in oxic marine sediments. *Earth Planet. Sci. Lett.*, **61**, 211-219.
- KLINKHAMMER, G., H. ELDERFIELD, M. GREAVE, P. RONA and T. NELSON (1986): Manganese geochemistry near high-temperature vents in the Mid-Atlantic Ridge rift valley. *Earth Planet. Sci. Lett.*, **80**, 230-240.
- KNAUSS, K. and T.-L. KU (1983): The elemental composition and decay-series radionuclide content of plankton from the East Pacific. *Chem. Geol.*, **39**, 125-145.
- KUNZENDORF, K., R. GWOZDZ, G. P. GLASBY, P. STOFFERS and R. M. RENNER (1989): The

- distribution of rare earth elements in manganese micronodules and sediments from the equatorial and southwest Pacific. *Appl. Geochem.*, **4**, 183-193.
- LALOU, C., E. BRICHET, C. JEHANNO and H. PEREZ-LECLAIRE (1983): Hydrothermal manganese oxide deposits from Galapagos mounds, DSDP Leg 70, hole 509B and "Alvin" dives 729 and 721. *Earth Planet. Sci. Lett.*, **63**, 63-75.
- LEE, D. S. and J. M. EDMOND (1985): Tellurium species in seawater. *Nature*, **313**, 782-785.
- LEVENTHAL, J. S. and J. W. HOSTERMAN (1982): Chemical and mineralogical analysis of Devonian black shale samples from Martin County, Kentucky; Carroll and Washington counties, Ohio; Wise County, Virginia; and Overton County, Tennessee, U. S. A. *Chem. Geol.*, **37**, 239-264.
- LI, Y.-H. (1981a): Ultimate removal mechanisms of elements from the ocean. *Geochim. Cosmochim. Acta*, **45**, 1659-1664.
- LI, Y.-H. (1981b): Geochemical cycles of elements and human perturbation. *Geochim. Cosmochim. Acta*, **45**, 2073-2084.
- LI, Y.-H. (1982a): A brief discussion on the mean oceanic residence time of elements. *Geochim. Cosmochim. Acta*, **46**, 2671-2675.
- LI, Y.-H. (1982b): Ultimate removal mechanisms of elements from the ocean (reply to a comment by M. WHITFIELD and D. R. TURNER). *Geochim. Cosmochim. Acta*, **46**, 1993-1995.
- LI, Y.-H. (1982c): Interelement relationship in abyssal Pacific ferromanganese nodules and associated sediments. *Geochim. Cosmochim. Acta*, **46**, 1053-1060.
- LI, Y.-H. (1984): Why are the chemical compositions of living organisms so similar? *Schweiz. Z. Hydrol.*, **46**, 177-184.
- LI, Y.-H. (1991): Distribution patterns of the elements in the ocean: A synthesis. *Geochim. Cosmochim. Acta*, **55**, 3223-3240.
- LI, Y.-H., L. BURKHARDT, M. BUCHHOLTZ, P. O'HARA and P. H. SANTSCHI (1984): Partition of radiotracers between suspended particles and seawater. *Geochim. Cosmochim. Acta*, **48**, 2011-2019.
- LYLE, M., J. DYMOND and G. R. HEATH (1977): Copper-nickel-enriched ferromanganese nodules and associated crusts from the Bauer Basin, northwest Nazca plate. *Earth Planet. Sci. Lett.*, **35**, 55-64.
- LYLE, M., G. R. HEATH and J. M. ROBBINS (1984): Transport and release of transition elements during early diagenesis: Sequential leaching of sediments from MANOP Sites M and H. Part I. pH5 acetic acid leach. *Geochim. Cosmochim. Acta*, **48**, 1705-1715.
- MALCOLM, S. J. (1985): Early diagenesis of molybdenum in estuarine sediments. *Mar. Chem.* **16**, 213-225.
- MANHEIM, F. T. (1961): A geochemical profile in the Baltic Sea. *Geochim. Cosmochim. Acta*, **25**, 52-71.
- MARCHIG, V. and H. GUNDLACH (1982): Iron-rich metalliferous sediments on the East Pacific Rise: prototype of undifferentiated metalliferous sediments on divergent plate boundaries. *Earth Planet. Sci. Lett.*, **58**, 361-382.
- MARCHIG, V., P. MÖLLER, H. BACKER and P. DULSKI (1985): Foraminiferal ooze from the Galapagos Rift area—hydrothermal impact and diagenetic mobilization of elements. *Mar. Geol.*, **62**, 85-104.
- MARTIN, J. H. and G. A. KNAUER (1973): The elemental composition of plankton. *Geochim. Cosmochim. Acta*, **37**, 1639-1653.
- MARTIN, J. H. and G. A. KNAUER (1983): VERTEX: manganese transport with CaCO<sub>3</sub>. *Deep-Sea Res.*, **30**, 411-425.
- MARTIN, J. H. and G. A. KNAUER (1984): VERTEX: manganese transport through oxygen minima. *Earth Planet. Sci. Lett.*, **67**, 35-47.
- MARTIN, J. H., G. A. KNAUER and W. W. BROENKOW (1985): VERTEX: the lateral transport of manganese in the northeast Pacific. *Deep-Sea Res.*, **32**, 1405-1427.
- MARTIN, J.-M. and M. WHITFIELD (1983): The significance of the river input of chemical elements to the ocean. p. 265-296. *In* C. S. WONG, E. BOYLE, K. W. BRULAND, J. D. BURTON and E. D. GOLDBERG (eds.), *Trace Metals in Sea Water*. Plenum Press, New York and London.
- MASON, B. and C. B. MOORE (1982): *Principles of Geochemistry*. John Wiley & Sons, New York, 344 pp.
- MASUZAWA, T., S. NORIKI, T. KUROSAWA and S. TSUNOGAI (1989): Composition change of settling particles with water depth in the Japan Sea. *Mar. Chem.*, **27**, 61-78.
- METZ, S., J. H. TREFRY and T. A. NELSEN (1988): History and geochemistry of a metalliferous sediment core from the Mid-Atlantic Ridge at 26°N. *Geochim. Acta*, **52**, 2369-2378.
- MIDDELBURG, J. J., D. HOEDE, H. A. VAN DER SLOOT, C. H. VAN DER WEIJDEN and J. WIJKSTRA (1988): Arsenic, antimony and vanadium in the North Atlantic Ocean. *Geochim. Cosmochim. Acta*, **52**, 2871-2878.
- MOORBY, S. A. and D. S. CRONAN (1981): The distribution of elements between co-existing phases

- in some marine ferromanganese-oxide deposits. *Geochim. Cosmochim. Acta*, **45**, 1855-1877.
- MOORBY, S. A. and D. S. CRONAN (1983): The geochemistry of hydrothermal and pelagic sediments from the Galapagos Hydrothermal Mounds Field, DSDP Leg 70. *Mineral. Mag.*, **47**, 291-300.
- MOORBY, S. A., D. S. CRONAN and G. P. GLASBY (1984): Geochemistry of hydrothermal Mn-oxide deposits from the S.W. Pacific island arc. *Geochim. Cosmochim. Acta*, **48**, 433-441.
- MOTTL, M. J. and T. F. MCCONACHY (1990): Chemical processes in buoyant hydrothermal plumes on the East Pacific Rise near 21° N. *Geochim. Cosmochim. Acta*, **54**, 1911-1927.
- NISSENBAUM, A. and D. J. SWAINE (1976): Organic matter-metal interactions in recent sediments: the role of humic substances. *Geochim. Cosmochim. Acta*, **40**, 809-816.
- PEDERSEN, T. F. and N. B. PRICE (1982): The geochemistry of manganese carbonate in Panama Basin sediments. *Geochim. Cosmochim. Acta*, **46**, 59-68.
- PILIPCHUK, M. F. and I. I. VOLKOV (1974): Behavior of molybdenum in processes of sediment formation and diagenesis in Black Sea. p. 542-553. *In* E. T. DEGENS and D. A. ROSS (eds.), *The Black Sea-Geology, Chemistry and Biology*. Am. Assoc. Pet. Geol. Mem., 20.
- PIPER, D. Z. (1988): The metal oxide fraction of pelagic sediment in the equatorial North Pacific Ocean: A source of metals in ferromanganese nodules. *Geochim. Cosmochim. Acta*, **52**, 2127-2145.
- PIPER, D. Z., K. LEONG and W. F. CANNON (1979): Manganese nodule and surface sediment compositions: DOMES Sites A, B, and C. p. 437-473. *In* J. L. BISCHOFF and D. Z. PIPER (eds.), *Marine Geology and Oceanography of the Pacific Manganese Nodule Province*. Plenum Press, New York and London.
- PIPER, D. Z., P. D. RUDE and S. MONTEITH (1987): The chemistry and mineralogy of haloed burrows in pelagic sediment at DOMES Site A: the equatorial North Pacific. *Mar. Geol.*, **74**, 41-55.
- PREMOVIC, P. I. and M. S. PAVLOVIC (1986): Vanadium in ancient sedimentary rocks of marine origin. *Geochim. Cosmochim. Acta*, **50**, 1923-1931.
- PRICE, N. B. and S. E. CALVERT (1973): The geochemistry of iodine in oxidized and reduced recent marine sediments. *Geochim. Cosmochim. Acta*, **37**, 2149-2158.
- PRICE, N. B. and S. E. CALVERT (1977): The contrasting geochemical behaviour of iodine and bromine in recent sediments from the Namibian shelf. *Geochim. Cosmochim. Acta*, **41**, 1769-1775.
- RONA, E. and O. JOENSU (1974): Uranium geochemistry in Black Sea. p. 570-572. *In* E. D. DEGENS and D. A. ROSS (eds.), *The Black Sea-Geology, Chemistry and Biology*. Am. Assoc. Pet. Geol. Mem., 20.
- RONA, P. A., G. THOMPSON, M. J. MOTTL, J. A. KARSON, W. J. JENKINS, D. GRAHAM, M. M ALLETTE, K. VON DAMM and J. M. EDMOND (1984): Hydrothermal activity at the Trans-Atlantic Geotraverse Hydrothermal Field, Mid-Atlantic Ridge crest at 26°N. *J. Geophys. Res.*, **89**, 11365-11377.
- RONA, P. A., G. KLINKHAMER, T. A. NELSEN, J. H. TREFRY and H. ELDERFIELD (1986): Black smokers, massive sulfides and vent biota at the Mid-Atlantic Ridge. *Nature*, **321**, 33-37.
- RUHLIN, D. E. and R. M. OWEN (1986): The rare earth element geochemistry of hydrothermal sediments from the East Pacific Rise: Examination of a seawater scavenging mechanism. *Geochim. Cosmochim. Acta*, **50**, 393-400.
- SANTSCHI, P. H., U. P. NYFFELER, P. O'HARA, M. BUCHHOLTZ and W. S. BROECKER (1984): Radiotracer uptake on the sea floor: results from the MANOP chamber deployments in the eastern Pacific. *Deep-Sea Res.*, **31**, 451-468.
- SATO, Y., S. OKABE and N. TAKEMATSU (1989): Major elements in manganese and iron oxides precipitated from seawater. *Geochim. Cosmochim. Acta*, **53**, 1883-1887.
- SAWLAN, J. J. and J. W. MURRAY (1983): Trace metal remobilization in the interstitial waters of red clay and hemipelagic marine sediments. *Earth Planet. Sci. Lett.*, **64**, 213-230.
- SCHINDLER, P. W. (1975): Removal of trace metals from the ocean: a zero order model. *Thalassia Jugosl.*, **11**, 101-111.
- SCHMITZ, B. (1985): Metal precipitation in the Cretaceous-Tertiary boundary clay at Stevens Klint, Denmark. *Geochim. Cosmochim. Acta*, **49**, 2361-2370.
- SCHMITZ, B. (1988): Origin of microlayering in worldwide distributed Ir-rich marine Cretaceous/Tertiary boundary clays. *Geology*, **16**, 1068-1072.
- SHAW, T. J., J. M. GIESKES and R. A. JAHNKE (1990): Early diagenesis in differing depositional environments: The response of transition metals in pore water. *Geochim. Cosmochim. Acta*, **54**, 1233-1246.
- SHEARME, S., D. S. CRONAN and P. A. RONA (1983):

- Geochemistry of sediments from the TAG Hydrothermal Field, M.A.R. at latitude 26° N. *Mar. Geol.*, **51**, 269-291.
- SMITH, R.M. and A. E. MARTELL (1976): Critical Stability Constants, Vol. 4: Inorganic Complexes. Plenum Press, New York and London, 257 pp.
- STOFFERS, P., G. P. GLASBY, T. THIJSEN, P. C. SHRIVASTAVA and M. MELGUEN (1981): The geochemistry of coexisting manganese nodules, micronodules, sediments and pore water from five areas in the equatorial and S. W. Pacific. *Chem. Erde*, **40**, 273-297.
- STOFFERS, P., E. LALLIER-VERGES, W. PLÜGER, W. SCHMITZ, C. BONNOT-COURTOIS and M. HOFFERT (1985): A "fossil" hydrothermal deposit in the South Pacific. *Mar. Geol.*, **62**, 133-151.
- STOFFERS, P., W. SCHMITZ, G. P. GLASBY, W. L. PLÜGER and P. WALTER (1985): Mineralogy and geochemistry of sediments in the South-western Pacific Basin: Tahiti-East Pacific Rise-New Zealand. *N. Z. J. Geol. Geophys.*, **28**, 513-530.
- STRONG, C. P., R. R. BROOKS, S. M. WILSON, R. D. REEVES, C. J. ORTH, X.-Y. MAO, L. R. QUINTANA and E. ANDERS (1987): A new Cretaceous-Tertiary boundary site at Flaxbounne River, New Zealand: Biostratigraphy and geochemistry. *Geochim. Cosmochim. Acta*, **51**, 2769-2777.
- SUGAWARA, K., T. KOYAMA and K. TERADA (1958): Co-precipitation of iodide ions by some metallic hydrated oxides with special reference to iodide accumulation in bottom water layers and interstitial water of muds in some Japanese lakes. *J. Earth Sci. Nagoya Univ.*, **6**, 52-61.
- SUGISAKI, R., M. OHASHI, K. SUGITANI and K. Suzuki (1987): Compositional variations in manganese micronodules: A possible indicator of sedimentary environments. *J. Geol.*, **95**, 433-454.
- TAKAYANAGI, K. and N. BELZILE (1988): Profiles of dissolved and acid-leachable selenium in a sediment core from the lower St. Lawrence Estuary. *Mar. Chem.*, **24**, 307-314.
- TAKEMATSU, N. (1979): The incorporation of minor transition metals into marine manganese nodules. *J. Oceanogr. Soc. Japan*, **35**, 191-198.
- TAKEMATSU, N. (1987): Ultimate removal of trace elements from seawater and adsorption. *J. Earth Sci. Nagoya Univ.*, **35**, 227-248.
- TAKEMATSU, N., Y. SATO and S. OKABE (1989): Factors controlling the chemical composition of marine manganese nodules and crusts: a review and synthesis. *Mar. Chem.*, **26**, 41-56.
- TAKEMATSU, N., Y. SATO, S. OKABE and A. USUI (1990): Uptake of selenium and other oxyanionic elements in marine ferromanganese concretions of different origins. *Mar. Chem.*, **31**, 271-283.
- THOMPSON, G., M. J. MOTT and P.A. RONA (1985): Morphology, mineralogy and chemistry of hydrothermal deposits from the TAG area, 26° N Mid-Atlantic Ridge. *Chem. Geol.*, **49**, 243-257.
- TOYODA, K. and A. MASUDA (1990): Sedimentary environments and chemical composition of Pacific pelagic sediments. *Chem. Geol.*, **88**, 127-141.
- TROCINE, R. P. and J. H. TREFRY (1988): Distribution and chemistry of suspended particles from an active hydrothermal vent site on the Mid-Atlantic Ridge at 26° N. *Earth Planet. Sci. Lett.*, **88**, 1-15.
- ULLMAN, W. J. and R. C. ALLER (1985): The geochemistry of iodine in near-shore carbonate sediments. *Geochim. Cosmochim. Acta*, **49**, 967-978.
- URRERE, M. A. and G. A. KNAUER (1981): Zooplankton fecal pellet fluxes and vertical transport of particulate organic material in the pelagic environment. *J. Plankton Res.*, **3**, 369-387.
- VEEH, H. H. (1967): Deposition of uranium from the ocean. *Earth Planet. Sci. Lett.*, **3**, 145-150.
- VEEH, H. H., S. E. CALVERT and N. B. PRICE (1974): Accumulation of uranium in sediments and phosphorites on the South West Africa shelf. *Mar. Chem.*, **2**, 189-202.
- VINE, J. D. and E. B. TOURTELOT (1970): Geochemistry of black shale deposits—a summary report. *Econ. Geol.*, **65**, 253-272.
- VOLKOV, I. I. and L. S. FOMINA (1974): Influence of organic material and processes of sulfide formation on distribution of some trace elements in deep-water sediments of Black Sea. p. 456-476. *In* E. T. DEGENS and D. A. ROSS (edS.), *The Black Sea—Geology, Chemistry and Biology*. Am. Assoc. Pet. Geol. Mem., 20.
- VON DAMM, K. L., J.M. EDMOND, B. GRANT, C. I. MEASURES, B. WALDEN and R.F. WEISS (1985): Chemistry of submarine hydrothermal solutions at 21° N, East Pacific Rise. *Geochim. Cosmochim. Acta*, **49**, 2197-2220.
- WALSH, I., J. DYMOND and R. COLLIER (1988a): Rates of recycling of biogenic components of settling particles in the ocean derived from sediment trap experiments. *Deep-Sea Res.*, **35**, 43-58.



- WALSH, I., K. FISCHER, D. MURRAY and J. DYMOND (1988b): Evidence for resuspension of rebound particles from near-bottom sediment traps. *Deep-Sea Res.*, **35**, 59-70.
- WEDEPOHL, K. H. (1960): Spurenanalytische Untersuchungen an Tiefseetonen aus dem Atlantik Ein Beitrag zur Deutung der geochemischen Sonderstellung von plagischen Tonen. *Geochim. Cosmochim. Acta*, **18**, 200-231.
- WEDEPOHL, K. H. (1969): Die Zusammensetzung der Erdkruste. *Fortschr. Miner.*, **46**, 145-174.
- WEDEPOHL, K. H. (1970): Environmental influences on the chemical composition of shales and clays. p. 305-333. *In* L. H. AHRENS, F. PRESS, S. K. RUNCORN and H. C. UREY (eds.), *Physics and Chemistry of the Earth*, Vol. 8. Pergamon Press, Oxford.
- WEHRLI, B. and W. STUMM (1989): Vanadyl in natural waters: Adsorption and hydrolysis promote oxygenation. *Geochim. Cosmochim. Acta*, **53**, 69-77.
- WHITFIELD, M. and D. R. TURNER (1979): Water-rock partition coefficients and the composition of seawater and river water. *Nature*, **278**, 132-137.
- WHITFIELD, M. and D. R. TURNER (1982): Ultimate removal mechanisms of elements from the ocean - a comment. *Geochim. Cosmochim. Acta*, **46**, 1989-1922.
- WHITFIELD, M. and D. R. TURNER (1983): Chemical periodicity and the speciation and cycling of the elements. p. 719-750. *In* C. S. WONG, E. BOYLE, K. W. BRULAND, J. D. BURTON and E. D. GOLDBERG (eds.), *Trace Metals in Sea Water*. Plenum Press, New York and London.
- WILLIAMS, R. J. P. (1981): Natural selection of the chemical elements. *Proc. R. Soc. Lond.*, **B213**, 361-397.
- WOOD, J. M. and H.-K. WANG (1983): Microbial resistance to heavy metals. *Environ. Sci. Technol.*, **17**, 582A-590A.
- YAMADA, M. and S. TSUNOGAI (1983/1984): Post-depositional enrichment of uranium in sediment from the Bering Sea. *Mar. Chem.*, **54**, 263-276.
- YAMAMOTO, T. (1972): The relations between concentration factor in seaweeds and residence time of some elements in sea water. *Rec. Oceanogr. Works Japan*, **11**, 65-79.
- YAMAMOTO, T., Y. OTSUKA, T. KAWASHIMA, Y. KODA, K. OKAMOTO and K. AOYAMA (1983): Distribution of Trace Element in Marine Algae - Comparative Biochemical Data - Kyoto University of Education, Kyoto, 499 pp.

## 海底堆積物中の元素の分布：概観と合成

竹 松 伸

要旨：鉄-マンガン酸化物が、微量元素の海水からのスキャベンジングおよびそれらの元素の海底堆積物への固定に、重要な役割を果たしていることを再評価した。1) 海水中の溶存態元素は、植物プランクトンによって摂取され、沈降粒子として海底に運ばれる。沈降粒子中の生物起源の成分は、水柱を降下する間に分解、再生され、深さと共に、陸起源のアルミノケイ酸塩鉱物の割合が増加する。酸素極少層以深では、鉄-マンガン酸化物が、微生物の媒介によって沈降粒子中に沈澱し、海水からの微量元素のスキャベンジングに重要な役割を果たす。2) 酸化的堆積物の化学組成は、頁岩の化学組成を持ったアルミノケイ酸塩鉱物と4つの起源の異なる鉄-マンガン団塊（水成起源、亜酸化的続成起源、酸化的続成起源および熱水起源）の化学組成を持った鉄-マンガン酸化物との混合物によって近似できる。3) マンガン酸化物も硫化鉄も存在し得ない沿岸堆積物は、頁岩の化学組成を持つ。それは、沈降粒子によって海底に運ばれてきた元素が、初期続成過程の間に再生され、堆積物から底層水中へ溶出してしまふからである。4) 硫化鉄が生成するような還元的環境では、親銅元素が堆積物中に濃縮する。5) 還元的堆積物の存在は狭い範囲に限られるので、多くの微量元素の現在の海水中の濃度および平均滞留時間は、これらの元素の鉄-マンガン酸化物への最終的編入機構によって支配されている。



## Seasonal variation of photosynthetic properties of *Ecklonia cava* (Laminariales, Phaeophyta) in Nabeta Bay, central Japan\*

Richard HAROUN\*\*, Yusho ARUGA\*\*\* and Yasutsugu YOKOHAMA\*\*\*\*

**Abstract:** The research was carried out to quantify the photosynthetic rates of a perennial seaweed *Ecklonia cava* KJELLMAN (Laminariales, Phaeophyta) with monthly samplings from April 1986 to April 1987. Photosynthesis and respiration were measured by a differential gas-volumeter in several bladelets. The photosynthesis-light curves were different among bladelets almost every month; however, in winter, when all the bladelets were new, the curves were quite similar. On a frond area basis, the youngest bladelets showed higher net photosynthesis than the older ones, with highest  $P_{max}$  values ( $44-49 \mu\text{IO}_2 \cdot \text{cm}^{-2} \cdot \text{h}^{-1}$ ) in early spring and lowest ( $19-31 \mu\text{IO}_2 \cdot \text{cm}^{-2} \cdot \text{h}^{-1}$ ) in autumn, the reproductive period. On a dry weight basis, the  $P_{max}$  values showed a hierarchical order inversely related to the thickness of the bladelets, with a maximum in the 2nd bladelet and a minimum in the 11th. On a chlorophyll *a* basis, the hierarchical order was similar to that on a dry weight basis, but  $P_{max}$  did not show any big seasonal variation. The respiration rate of each bladelet was quite stable throughout the year, except for the 2nd bladelet with two high peaks in November and February, the formation periods of autumn and winter bladelets respectively. The photosynthetic response of *E. cava* blade is closely related to its growth process. The blade of this species apparently adjusts its pigment content to the prevailing light conditions in the surrounding water.

### Introduction

As in terrestrial plants, light is the most important factor affecting the biology of seaweeds. Besides its primary importance in the photosynthesis, light is a signal for numerous photomorphogenetic responses such as reproduction, growth and distribution (LÜNING, 1980, 1981; NOVACZEK, 1984; LOBBAN *et al.*, 1985; MAEGAWA *et al.*, 1987). The photosynthetic rates of large seaweeds have scarcely been studied due to the difficulties encountered in handling these algae (DREW, 1973; JASBBY,

1978; KREMER, 1978; LITTLER and LITTLER, 1985). YOKOHAMA and ICHIMURA, (1969) devised a differential gas-volumeter for measuring  $\text{O}_2$  consumption or evolution by aquatic organisms, and several papers have been published dealing with the photosynthetic characteristics of various seaweeds (YOKOHAMA, 1971, 1973a, b; MIZUSAWA *et al.*, 1978; OOHUSA, 1980; KATAYAMA *et al.*, 1985; MAEGAWA *et al.*, 1987). This manometric method has been improved allowing easier measurements for macrophytes or small marine animals (YOKOHAMA *et al.*, 1986; YOKOHAMA and MAEGAWA, 1988).

The sporophytes of *Ecklonia cava* KJELLMAN are widely distributed on rocky shores along the Pacific coast of central Japan. In previous papers (ARUGA, 1981; YOKOHAMA *et al.*, 1987) it was reported that the standing crop of *E. cava* communities attains a maximum in summer and a minimum in winter; this is mainly related to the seasonal variation of the blade growth process (HAROUN *et al.*, 1989). Recently, SAKANISHI *et al.* (1988) developed a suitable treatment of

\* Received December 1, 1991

Contribution No. 549 from the Shimoda Marine Research Center, University of Tsukuba.

\*\* Departamento Biología Vegetal, Facultad de Biología, Universidad de La Laguna, 38271 La Laguna, Tenerife, Islas Canarias, Spain

\*\*\* Laboratory of Phycology, Tokyo University of Fisheries, Konan 4-5-7, Minato-ku, Tokyo, 108 Japan

\*\*\*\* Shimoda Marine Research Center, University of Tsukuba, Shimoda, Shizuoka, 415 Japan

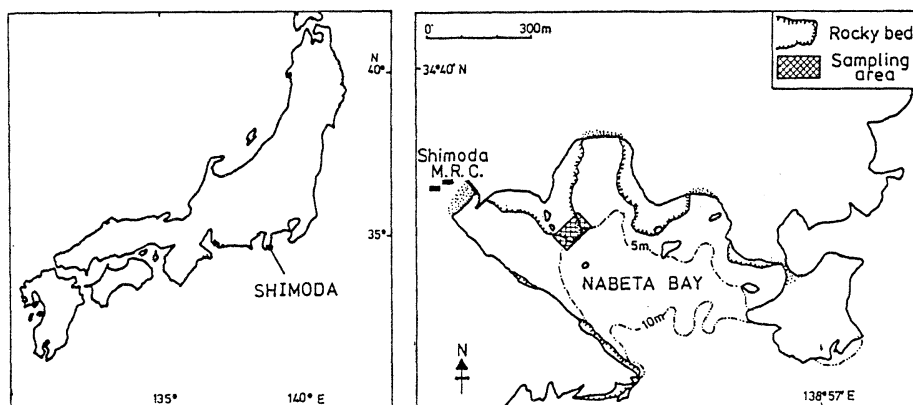

Fig. 1. Maps showing the sampling area in Nabeta Bay, Shimoda, central Japan.

tissue segments from the thalli of *Ecklonia* and *Eisenia* to measure the photosynthesis of these Laminariales species by the above-mentioned oxygen technique.

The present investigation was done to measure the photosynthetic rates of the pinnate blade of *Ecklonia cava* during one-year period. Another objective in the study was to investigate the relationship between physiological activity and the phenology of the blade. Finally, we try to relate the annual pattern of photosynthetic response to some possible environmental factors.

#### Material and methods

Morphologically, the *E. cava* sporophyte can be divided into three parts: a holdfast, a long stipe (more than 50 cm long in adult plants) and a pinnate blade composed of lateral bladelets (HAYASHIDA, 1977; MAEGAWA and KIDA, 1984). As in other species of Laminariales, primary growth is concentrated in the transitional zone between stipe and blade. When growth is initiated, the primary blade moves upward, developing several bladelets in both sides (usually with lateral protuberances); while the sporophyte erodes from the distal ends of both primary blade and bladelets.

The research was carried out at Shimoda Marine Research Center (S.M.R.C.), University of Tsukuba, close to Nabeta Bay, Shimoda (Izu Peninsula), with monthly samplings from April 1986 to April 1987. Every month 4 adult plants were randomly sampled from a homogeneous population of *E. cava* at 5 m depth (Fig. 1). All

the plants were quickly transferred to S.M.R.C. and were kept in outdoor tanks supplied with flowing seawater before use. Special care was taken not to wound the frond and to protect them from direct sunlight. Pieces measuring 15 cm<sup>2</sup> were cut out from the central part of the 2nd, 5th, 8th and 11th bladelets longer than 10 cm as numbered starting from the proximal part of the blade. In January there were not 8th or 11th bladelets available due to the shortness of the blade. To avoid abnormal results caused by cutting, the pieces were kept in running seawater overnight in the laboratory (SAKANISHI *et al.*, 1988). At the same time, small discs (0.73 cm<sup>2</sup>) of the bladelets were taken and frozen for quantitative analyses of chlorophylls.

Photosynthesis and respiration were measured by a differential gas-volumeter adapted for large seaweed pieces, with four set of culture flasks of 250 ml capacity as the reaction and compensation vessels (YOKOHAMA and MAEGAWA, 1988). All the measurements were done at 20 °C and with an illuminance gradient of 0 to 20 klux (0–400  $\mu\text{E}\cdot\text{m}^{-2}\cdot\text{s}^{-1}$ ) by using a slide projector with an incandescent lamp (Kondo, 100V 300W) as a light source. The illuminance was changed in a stepwise fashion with neutral density filters (Toshiba TND-50, -25 and -12.5). Illuminance and photon flux density were measured by a lux meter (Minolta T-1) and a quantum meter (LI-COR LI-185b/LI-192S).

The discs for the determination of chlorophyll content were ground with 90 % acetone and the absorbances of the extract were measured at 630 and 664 nm with a dual beam spectrophotometer

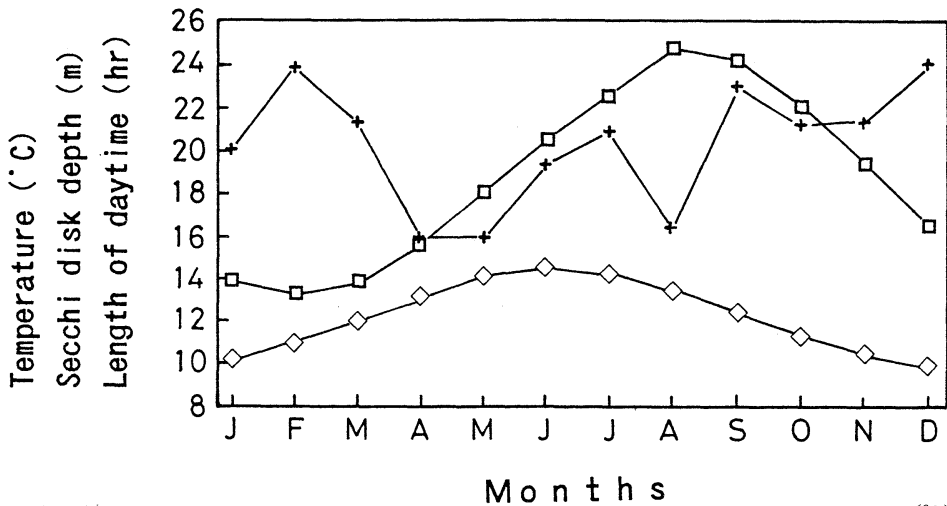

Fig. 2. Seasonal variation of environmental parameters studied. □ Temperature (°C), + Secchi disk depth (m) and ◇ Length of daytime (hr).

(Shimadzu UV-320). Chlorophyll *a* and *c* concentrations were calculated using the formulae of JEFFREY and HUMPHREY (1975).

All the procedures were repeated monthly at least with 3 replicates for each bladelet. Afterwards, a statistical analysis was applied and the average of all measurements for each bladelet was used as the monthly values for that bladelet.

As possible environmental control, the following parameters were studied: seawater temperature and Secchi disc depth as well as the length of daytime (Fig. 2). The seawater temperature at Nabeta Bay was daily obtained by the S.M.R.C. staff (Anon., 1981-1986). There is a minimum in mid-winter (February, 12.8 °C), and a maximum in late summer (August, 25 °C). As an indirect measure of light conditions in Nabeta Bay water, was used the Secchi disc depth measured in Sagami Bay off Shimoda (HOGETSU *et al.*, 1977). The maximal values were found in mid-winter (20-24m) and the minimal ones were recorded during the summer months (13-18m). The same trend was also observed in Nabeta Bay. The seasonal variation of the length of daytime at Shimoda was obtained from the National Meteorological Datum.

## Results

### Photosynthesis-light curves

Photosynthesis-light curves are illustrated in

Fig. 3 on a frond area bases, a dry weight basis and a chlorophyll *a* basis for the July, October, December and March samples. In all the cases, the photosynthetic rates increased with increase of illuminance within the range used in this study. The light-limited part of each curve was quite similar among the bladelets, but when the illuminance increased the response of each bladelet was different.

### Seasonal variation of $P_{max}$

The net photosynthetic rates at 20 klux, henceforth considered as  $P_{max}$ , were maximal in winter-early spring ( $44-49 \mu\text{O}_2 \cdot \text{cm}^{-2} \cdot \text{h}^{-1}$ ,  $5.3-9.2 \mu\text{O}_2 \cdot \text{mg}^{-1} \cdot \text{h}^{-1}$  and  $1.3-2.2 \mu\text{O}_2 \cdot \mu\text{g chl. } a^{-1} \cdot \text{h}^{-1}$ ) and minimal in early autumn ( $19-30 \mu\text{O}_2 \cdot \text{cm}^{-2} \cdot \text{h}^{-1}$ ,  $0.8-2.7 \mu\text{O}_2 \cdot \text{mg}^{-1} \cdot \text{h}^{-1}$  and  $0.5-0.9 \mu\text{O}_2 \cdot \mu\text{g chl } a^{-1} \cdot \text{h}^{-1}$ ). The  $P_{max}$  on a dry weight basis began to increase as early as in November (in the 2nd bladelet), and reached maximal values in March, thereafter they gradually declined to the minimal values of September or October (Fig. 4). The decline of  $P_{max}$  from winter to late summer was more drastic on a dry weight basis than on a frond area basis or on a chlorophyll *a* basis. The dominant hierarchical order of  $P_{max}$  on a dry weight basis was 2nd, 5th, 8th and 11th bladelets from high to low performance; however, in mid-winter the  $P_{max}$  values were quite similar among the bladelets. From November to January, the bladelets formed in autumn

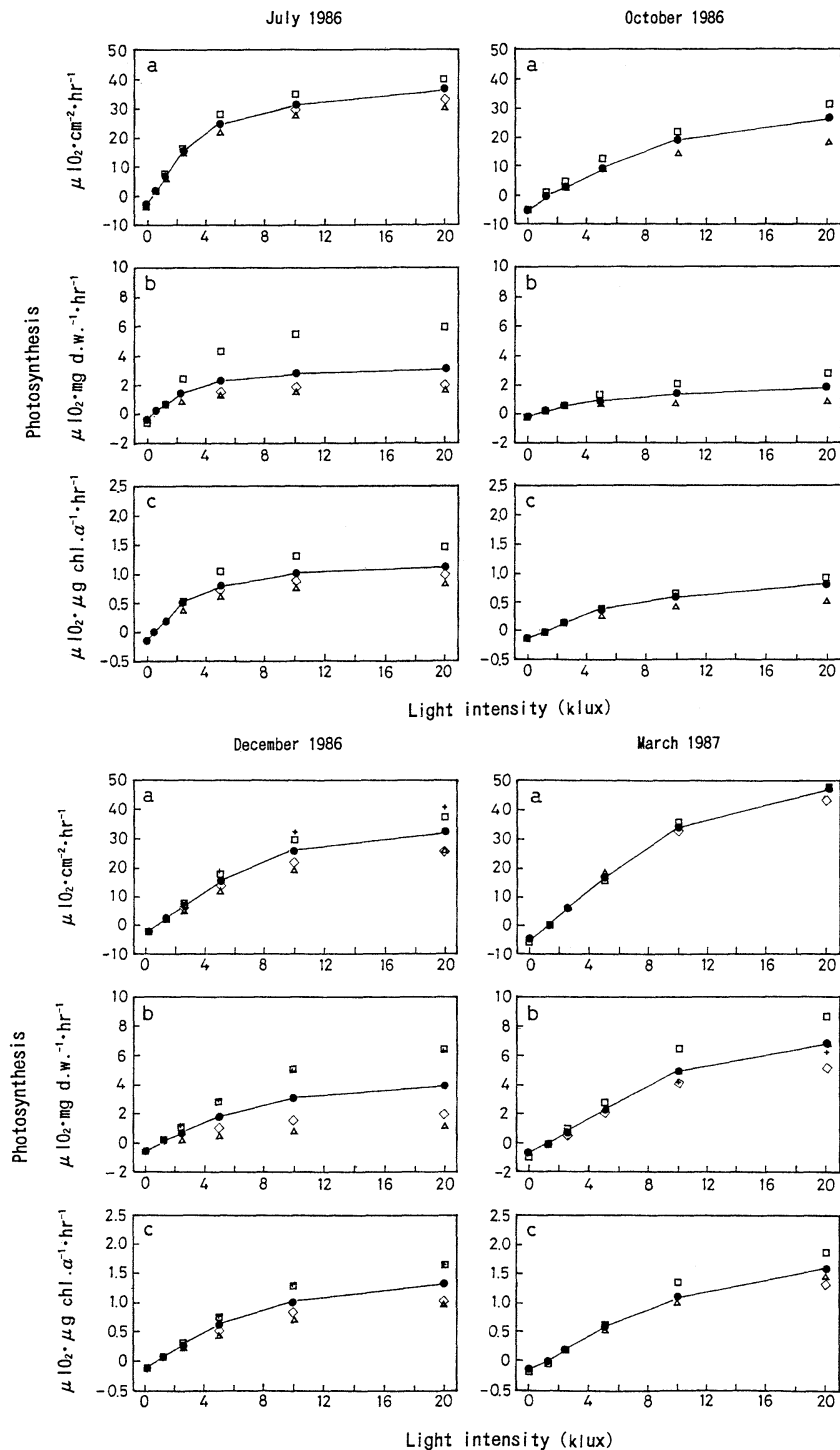

Fig. 3. Photosynthesis-light curves of each bladelet and the average of *Ecklonia cava* blade on a frond area, on a dryweight and on a chlorophyll *a* bases in selected months (July, October and December 1986, and March 1987). □ 2nd, + 5th, ◇ 8th, △ 11th and ● average.

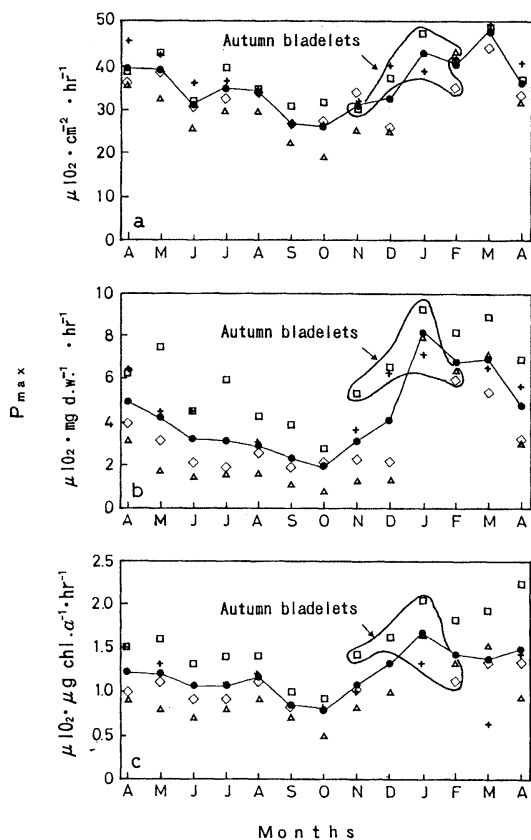

Fig. 4. Relationship between the seasonal variation of  $P_{max}$  on a frond area, on a dry weight and on a chlorophyll *a* bases of each bladelet and the phenological state of *Ecklonia cava* blade (April 1986 - April 1987).  $\square$  2nd,  $+$  5th,  $\diamond$  8th,  $\triangle$  11th and  $\bullet$  average.

showed specifically high photosynthetic rates.

#### Seasonal variation of respiration rates

Both on a frond area basis and on a chlorophyll *a* basis, the monthly average of respiration rate did not show any big variation,  $2.7\text{--}4.8 \mu\text{O}_2 \cdot \text{cm}^{-2} \cdot \text{h}^{-1}$  and  $0.1\text{--}0.2 \mu\text{O}_2 \cdot \mu\text{g chl. a}^{-1} \cdot \text{h}^{-1}$ , during the period of study with relatively low values in December and March. On the other hand, the variations were bigger on a dry weight basis,  $0.2\text{--}0.8 \mu\text{O}_2 \cdot \text{mg}^{-1} \cdot \text{h}^{-1}$  (Fig. 5).

Comparing the monthly variation of the respiration rate of each bladelet, it is possible to get some suggesting trends. In any of the bases considered, the respiration rate of the 2nd

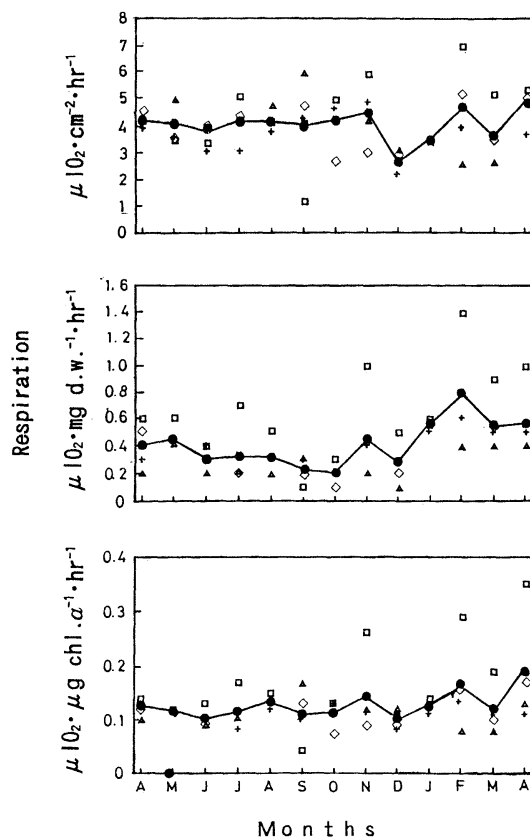

Fig. 5. Seasonal variation of respiration rate of each bladelet and the average of *Ecklonia cava* blade on a frond area, on a dry weight and on a chlorophyll *a* bases (April 1986 - April 1987).  $\square$  2nd,  $+$  5th,  $\diamond$  8th,  $\triangle$  11th and  $\bullet$  average.

bladelet showed a greater oscillation than those of the other bladelets, with a minimal values in September and two maximal values in November and in February. The high respiration rate on a chlorophyll *a* basis in April 1987 of the 2nd bladelet was due to the abnormally low content of chlorophyll *a* in the replicate samples used; there is no good explanation for this result.

#### Seasonal variations of compensation point ( $I_c$ ) and saturation onset parameter ( $I_k$ )

Both parameters were calculated from the photosynthesis-light curves. As the values were quite similar among the curves irrespective of the different bases, only the values on a frond area basis are used in this paper (Fig. 6).

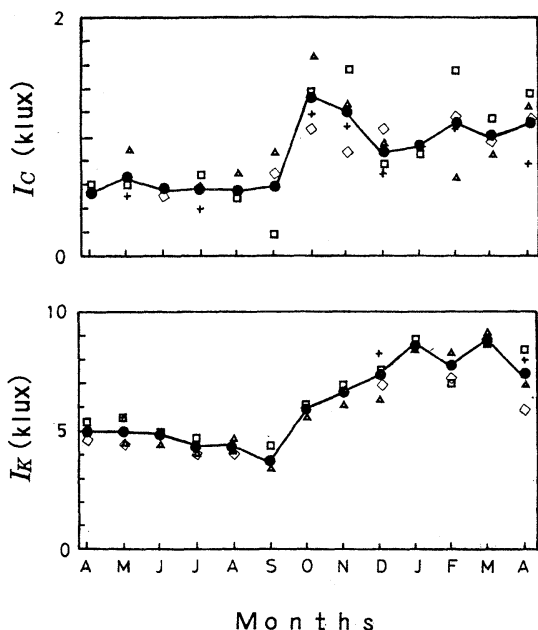

Fig. 6. Seasonal variation of  $I_c$  and  $I_k$  of each bladelet and the average of *Ecklonia cava* blade on a frond area basis (April 1986–April 1987). □ 2nd, + 5th, ◇ 8th, △ 11th and ● average.

In the case of  $I_c$  (Fig. 6A), lower values were found during the spring-summer period, 0.2–0.9 klux ( $3.3$ – $16.6 \mu E \cdot m^{-2} \cdot s^{-1}$ ), while higher values were obtained from autumn to the next spring, 0.7–1.7 klux ( $11.5$ – $31.6 \mu E \cdot m^{-2} \cdot s^{-1}$ ), with the highest average value in October.

The saturation onset parameter  $I_k$  (Talling, 1957; Kirk, 1983) was higher than 3 klux ( $60 \mu E \cdot m^{-2} \cdot s^{-1}$ ). The trend of the seasonal variation of  $I_k$  was similar to that of  $I_c$  with lower values in spring-summer and higher values in autumn-winter.

#### Seasonal variation of chlorophyll content and dry weight

Figure 7 shows the variations of chlorophyll *a* and *c* contents per unit area of the bladelet. In all the bladelets, the chlorophyll *a* content was minimal from November to January, wherefrom it started to increase (Fig. 7A). The chlorophyll *a* content was always lower in the 2nd bladelet and almost always highest in the 11th bladelet. During the winter months all

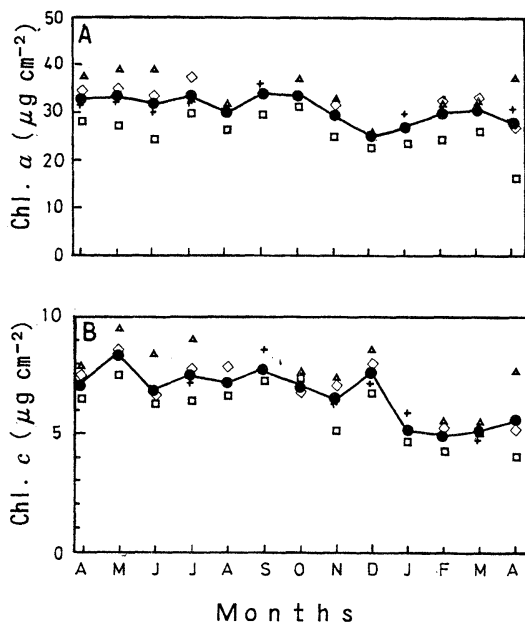

Fig. 7. Seasonal variation of chlorophyll *a* and *c* contents of each bladelet and the average of *Ecklonia cava* blade (April 1986–April 1987). □ 2nd, + 5th, ◇ 8th, △ 11th and ● average.

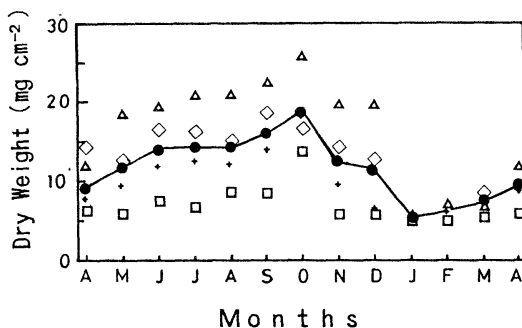

Fig. 8. Seasonal variation of dry weight of each bladelet and the average of *Ecklonia cava* blade (April 1986–April 1987). □ 2nd, + 5th, ◇ 8th, △ 11th and ● average.

bladelets showed lower values than during spring-early summer period, except for big differences in April 1987.

The chlorophyll *c* content was also low during winter time in the new bladelets, which were formed from November to January, but it was high in other seasons (Fig. 7B). Moreover, the pigment content was usually lower in the



younger bladelets (2nd and 5th) than in the older ones (8th and 11th).

In the dry weight per unit area of the bladelet (Fig. 8), there was a clear seasonal variation. A progressive thickening in all bladelets was observed from spring to early autumn, thereafter a quick decrease was measured to reach the minimal values of mid-winter. Usually the oldest bladelets showed higher values than the youngest ones; but in mid-winter the dry weight of the four bladelets considered was quite similar.

### Discussion

In general, the photosynthetic response of algae can be characterized by the parameters  $P_{max}$ ,  $I_k$ ,  $I_c$  and dark respiration, allowing easy comparison among the published data (STEEMANN NIELSEN, 1975 + DRING, 1982). In this study photosynthesis-light curves were monthly obtained with four different bladelets of *E. cava*. The photosynthetic response of each bladelet was distinct with the position in the blade and with seasons. These results are related to the specific developmental stages monthly encountered on each bladelet. The saturating irradiation recorded in this study is in the range described by LÜNING (1981) for mid-sublittoral species, i.e.  $150-250 \mu E \cdot m^{-2} \cdot s^{-1}$  (7-12 klux). In a recent paper (MAEGAWA *et al.*, 1987), it was reported that the level of light saturation for photosynthesis in young sporophytes of *E. cava* was lower (3-4.8 klux) as a consequence of their understory life and the lower amount of non-photosynthetic tissues (holdfast, stipe and medullary layer); the same trend was found in other Laminariales species (KAIN, 1979; NOVACZEK, 1984). SMITH (1981) also reported much lower  $I_k$  (about 2.5 klux) in a brown alga, *Lobophora variegata*, which forms thick rippled sheets in sublittoral waters, probably due to its higher surface/volume ratio. In several species of *Sargassum* from the shallow sublittoral zone of the Japan Sea their  $I_k$  values were quite similar to those of *E. cava*, while  $I_k$  was higher in *S. thunbergii* (MERTENS ex ROTH) O. KUNTZE which inhabits the intertidal zone (GAO and UMEZAKI, 1988) than in *E. cava* of this study.

The shift of low  $I_k$  and  $P_{max}$  values in summer months to high values of winter months in *E.*

*cava* is possibly related to the different thickness of the bladelets as suggested by the results of LÜNING and DRING (1985) about light transmittance through algal thalli and also by the results of MAEGAWA *et al.* (1987) who compared photosynthesis when the blade of young *E. cava* sporophytes was illuminated from one side and from both sides. Thin bladelets and high transparency of seawater reported in this study together with low leaf area index (LAI) (YOKOHAMA *et al.*, 1987) allow high photosynthesis efficiency in mid-winter, but in summer with thick bladelets, low transparency and mutual shading of the canopy (high LAI; see YOKOHAMA *et al.*, 1987) the efficiency of photosynthesis becomes lower. In addition, water temperature is an important factor in the regulation of photosynthetic metabolism by controlling pigment concentration and/or activities of the Calvin cycle enzymes (DAVISON, 1987; DAVISON and DAVISON, 1987). In *E. cava* blade, the slowdown of the growth rate from July, when the seawater temperature goes up higher than  $22^\circ C$ , was inversely correlated with the reproductive activity (HAROUN *et al.*, 1989). The low  $P_{max}$  values in June is probably related to an endogenous shift of metabolism from the production of new bladelets to the formation of sori and the reserve of photoassimilates in the summer bladelets.

WHEELER (1980) working with *Macrocystis pyrifera* (L.) C. AG. described that the photosynthesis capacity on a frond area basis of selected fronds increased from the apical to the median blade and then decreased towards the basal sporophylls. ARUGA (1983) recorded the highest  $P_{max}$  in subproximal bladelets of *E. cava* which approximately correspond to the 5th bladelet of this study. MATSUYAMA (1983) obtained the highest  $P_{max}$  in the longest lobe of *Undaria pinnatifida* SURINGER f. *distans* MIYABE et OKAMURA, with a drastic reduction of photosynthesis capacity towards the eroding apical part of the blade.

The seasonal variation of  $P_{max}$  values is closely related with the physiological stages of the bladelets and the annual growth cycle of the blade (HAROUN *et al.*, 1989). From late spring to early autumn the blade thickened and entered the reproductive period and, at the same time,

$P_{max}$  decreased in overall bladelets; from November, however, with the onset of new blade formation there was a clear change in the photosynthetic response of the bladelets. In mid-winter the bladelets are all fresh and thin, with a high photosynthetic performance. The observed lowering of  $P_{max}$  can be explained by the concurrent thickening of the blade from spring to autumn (Fig. 8), which usually starts from the upper bladelets. In November, the measurements of the 2nd bladelet were carried out on newly developed bladelets with very thin laminae. In general the youngest bladelets showed lower content of chlorophylls compared with the oldest bladelets. WHEELER (1980) with *M. pyrifera* fronds and GAO and UMEZAKI (1988) with *Sargassum* spp. also found less pigments in the youngest parts of the thalli. Another remarkable fact is that the chlorophyll *a* content of the autumn bladelets, which appeared from November to January, showed minimal values, and from that time on a slow increase was measured for all bladelets (Fig. 7). Thus, the difference in photosynthetic responses can be explained by the rapid increase in dry weight of the bladelets from April to October compared with the slow filling in of chlorophylls. As algae can modify and optimize their photosynthetic systems in an adaptative fashion according to their seasonal light climate (RAMUS *et al.*, 1976; KIRK, 1983; LOBBAN *et al.*, 1985), the blade of *E. cava* seems to shift its pigment content in relation to the prevailing light conditions.

The big oscillation in the respiration rate of the 2nd bladelet can be explained by the different developmental stages of that bladelet. In September, there was almost no growth in the 2nd bladelet, while in November the autumnal 2nd bladelet was growing very actively, and the new 2nd bladelet of February was also growing very fast. Respiration rates were also greater in the young, upper part leaves of *Sargassum* spp. compared with the older leaves from lower parts (GAO and UMEZAKI, 1988).

KING and SCHRAMM (1976) described the variation of  $P_{max}$  in two Baltic Sea algae, *Fucus vesiculosus* and *Laminaria digitata*, using different thallus portions. In their study,  $P_{max}$  values on a frond area basis were not very distinct

among the segments, but on a dry weight basis the subterminal portion showed a higher value compared to the basal portion. In this research we found a positive relationship between the bladelet position and their dry weight per unit area. Following the above-mentioned trend, in *E. cava* there is a negative relationship between the photosynthesis capacity on a dry weight basis and the bladelet position; the respiration rate was also higher in the youngest bladelet compared with others.

Taking into consideration other studies on *E. cava* (ARUGA, 1981, 1982, 1983; YOKOHAMA *et al.*, 1987) and the previously described annual growth cycle (HAROUN *et al.*, 1989) it is possible to define the blade of this species as a "conveyer belt" that would renew its biomass 3 times per year. One blade appears in autumn, with short and thin bladelets having low chlorophyll content. This blade would live until early winter when it is substituted by the winter blade having longer but still thin bladelets with higher content of chlorophylls. Finally, during the summer the blade biomass is composed of long and thick bladelets with a progressive decrease in pigments. In late autumn, large pieces of the blade are broken off and the resultant organic matter will eventually participate in the detrital trophic chains of coastal waters.

The photosynthetic responses of *E. cava* blade is closely related to its annual growth cycle. The distinct photosynthetic performance of the bladelets is a consequence of their ontogenetic differentiation. Growth and photosynthesis metabolisms seem to be mainly controlled by seawater temperature and light conditions.

#### Acknowledgments

Our sincere thanks are extended to the staff of the Shimoda Marine Research Center, University of Tsukuba and the Phycology Laboratory, Tokyo University of Fisheries. We also thank Dr. H. SATOH, Tokyo University of Fisheries, and Dr. Y. YAMAGUCHI, Saitama University, for their kindness in drawing figures.

#### References

- Anonymous (1981-1986): Report of Coastal Observations. Shimoda Mar. Res. Center, Univ. Tsukuba, 31-36, 1-7.

- ARUGA, Y. (1981): Physiological characteristics of *Eisenia bicyclis* and *Ecklonia cava*. Marine Ranching Program 1980, 29-34 (in Japanese).
- ARUGA, Y. (1982): Physiological characteristics of *Eisenia bicyclis* and *Ecklonia cava*. Marine Ranching Program 1981, 19-24 (in Japanese).
- ARUGA, Y. (1983): Physiological characteristics of *Eisenia bicyclis* and *Ecklonia cava*. Marine Ranching Program 1982, 19-27 (in Japanese).
- DAVISON, I. (1987): Adaptation of photosynthesis in *Laminaria saccharina* (Phaeophyta) to changes in growth temperature. *J. Phycol.*, **23**, 273-283.
- DAVISON, I. and J. O. DAVISON (1987): The effect of growth temperature on enzyme activities in the brown alga *Laminaria saccharina*. *Br. phycol. J.*, **22**, 77-87.
- DREW, E. A. (1973): Primary production of large marine algae measured *in situ* using uptake of  $^{14}\text{C}$ . In UNESCO (ed.), *Monogr. Oceanogr. Methodol.*, 3. A Guide to the Measurements of Marine Primary Production under Special Conditions. Paris. p. 22-26.
- DRING, M. J. (1982): *The Biology of Marine Plants*. Edward Arnold Publ., London. 199pp.
- GAO, K. and I. UMEZAKI (1988): Comparative photosynthetic capacities of the leaves of upper and lower parts of *Sargassum* plants. *Bot. mar.*, **31**, 231-236.
- HAROUN, R., Y. YOKOHAMA and Y. ARUGA (1989): Annual growth cycle of the brown alga *Ecklonia cava* in central Japan. *Scient. Mar.* **53**, 349-356.
- HAYASHIDA, F. (1977): On age and growth of a brown alga, *Ecklonia cava* KJELLMAN, forming aquatic forest. *Bull. Jpn. Soc. Sci. Fish.*, **43**, 1043-1051 (in Japanese with English summary).
- HOGETSU, K., M. HATANAKA, T. HANAOKA and T. KAWAMURA (1977): Productivity of Biocenoses in Coastal Regions of Japan. *JIBP Synthesis*, Vol. 14. Univ. Tokyo Press, Tokyo. 394 pp.
- JASSBY, A. D. (1978): Polarographic measurements of photosynthesis and respiration. In J. A. Hellebust and J. S. Craigie (eds.), *Handbook of Phycological Methods. Physiological and Biochemical Methods*. Cambridge Univ. Press, Cambridge. p. 285-295.
- JEFFREY, S. W. and G. F. HUMPHREY (1975): New spectrophotometric equations for determining chlorophylls *a*, *b*, *c*<sub>1</sub> and *c*<sub>2</sub> in higher plants, algae and natural phytoplankton. *Biochem. Physiol. Pflanzen*, **167**, 191-194.
- KAIN, J. M. (1979): A view of the genus *Laminaria*. *Oceanogr. Mar. Biol. Ann. Rev.*, **17**, 101-161.
- KATAYAMA, N., Y. TOKUNAGA and Y. YOKOHAMA (1985): Effect of growth temperature on photosynthesis-temperature relationships of a tide pool alga *Cladophora rudolphiana* (Chlorophyceae). *Jpn. J. Phycol.*, **33**, 312-316.
- KING, R. J. and W. SCHRAMM (1976): Determination of photosynthetic rates for the marine algae *Fucus vesiculosus* and *Laminaria digitata*. *Mar. Biol.*, **37**, 209-213.
- KIRK, J. T. O. (1983): *Light and Photosynthesis in Aquatic Ecosystems*. Cambridge Univ. Press, Cambridge. 401 pp.
- KREMER, B. P. (1978): Determination of photosynthetic rates and  $^{14}\text{C}$  photoassimilatory products of brown seaweeds. In J. A. Hellebust and J. S. Craigie (eds.), *Handbook of Phycological Methods. Physiological and Biochemical Methods*. Cambridge Univ. Press, Cambridge. p. 269-283.
- LITTLER, M. M. and D. S. LITTLER (1985): *Handbook of Phycological Methods. Ecological Field Methods: Macroalgae*. Cambridge Univ. Press, Cambridge. 617 pp.
- LOBBAN, C. S., P. J. HARRISON and M. J. DUNCAN (1985): *The Physiological Ecology of Seaweeds*. Cambridge Univ. Press, Cambridge. 242 pp.
- LÜNING, K. (1980): Control of algal life-history by daylength and temperature. In J. H. PRICE, D. E. G. IRVINE and W. F. FARNHAM (eds.), *The Shore Environment. Vol 2: Ecosystems*. Academic press, London. p. 915-945.
- LÜNING, K. (1981): Photobiology of seaweeds: ecophysiological aspects. *Proc. 10th Inter. Seaweed Symp.* p. 35-55.
- LÜNING, K. and M. J. DRING (1985): Action spectra and spectral quantum yield of photosynthesis in marine macroalgae with thin and thick thalli. *Mar. Biol.*, **87**, 119-129.
- MAEGAWA, M. and W. KIDA (1984): Ecological studies on *Eisenia bicyclis* and *Ecklonia cava* communities - IV. Seasonal change in allometric relation of *Ecklonia* frond. *Bull. Fac. Fish., Mie Univ.*, **11**, 199-206 (in Japanese with English summary).
- MAEGAWA, M., Y. YOKOHAMA and Y. AURGA (1987): Critical light conditions for young *Ecklonia cava* and *Eisenia bicyclis* with reference to photosynthesis. *Hydrobiologia*, **151/152**, 447-455.
- MATSUYAMA, K. (1983): Photosynthesis of *Undaria pinnatifida* SURINGAR f. *distans* MIYABE et OKAMURA (Phaeophyceae) from Oshoro Bay. II. Photosynthetic rates in several portions of the thallus. *Sci. Rep. Hokkaido Fish. Exp.*

- Sta., 25, 195-200 (in Japanese with English summary).
- MIZUSAWA, M., A. KAGEYAMA and Y. YOKOHAMA (1978): Physiology of benthic algae in tide pools I. Photosynthesis-temperature relationships in summer. Jpn. J. Phycol., 26, 109-114.
- NOVACEK, I. (1984): Development and phenology of *Ecklonia radiata* at two depths in Goat Island Bay, New Zealand. Mar. Biol., 81, 189-197.
- OOHUSA, T. (1980): Diurnal rhythm in the rates of cell division, growth and photosynthesis of *Porphyra yezoensis* (Rhodophyceae) cultured in the laboratory. Bot. mar., 23, 1-5.
- RAMUS, J., S. I. BEARLE and K. L. HOWARD (1976): Changes in photosynthetic pigment concentration in seaweeds as function of water depth. Mar. Biol., 37, 223-229.
- SAKANISHI, Y., Y. YOKOHAMA and Y. ARUGA (1988): Photosynthesis measurement of blade segments of brown algae *Ecklonia cava* KJELLMAN and *Eisenia bicyclis* SETCHELL. Jpn. J. Phycol., 36, 24-28.
- SMITH, W. O. (1981): Photosynthesis and productivity of benthic macroalgae on the North Carolina continental shelf. Bot. mar., 24, 279-284.
- STEEMANN NIELSEN, E. (1975): Marine Photosynthesis with Special Emphasis on the Ecological Aspects. Elsevier Sci. Publ., Amsterdam. 141 pp.
- TALLING, J. F. (1957): Photosynthetic characteristics of some freshwater plankton diatoms in relation to underwater radiation. New Phytol., 56, 29-50.
- WHEELER, W. N. (1980): Pigment content and photosynthetic rate of the frond of *Macrocystis pyrifera*. Mar. Biol., 56, 97-102.
- YOKOHAMA, Y. (1971): Photosynthesis-temperature relationships in several benthic marine algae. Proc. VIIth Inter. Seaweed Symp. p. 286-291.
- YOKOHAMA, (1973a): Photosynthetic properties of marine benthic green algae from different depths in the coastal area. Bull. Jpn. Soc. Phycol., 21, 70-75.
- YOKOHAMA, Y. (1973b): A comparative study on photosynthesis-temperature relationships and their changes in marine benthic algae. Int. Revue ges. Hydrobiol., 58, 467-476.
- YOKOHAMA, Y. and S. ICHIMURA (1969): A new device of differential gas-volumeter for ecological studies on small aquatic organisms. J. Oceanogr. Soc. Japan, 25, 75-80.
- YOKOHAMA, Y. and M. MAEGAWA (1988): Measurements of photosynthesis and respiration of large samples by "Productmeter", a differential gas-volumeter. Jpn. J. Phycol., 36, 29-36.
- YOKOHAMA, Y., N. KATAYAMA and K. FURUYA (1986): An improved type of "Productmeter", a differential gas-volumeter, and its application to measuring photosynthesis of seaweeds. Jpn. J. Phycol., 34, 37-42.
- YOKOHAMA, Y., J. TANAKA and M. CHIHARA (1987): Productivity of the *Ecklonia cava* community in a bay of Izu Peninsula on the Pacific coast of Japan. Bot. Mag. Tokyo, 100, 129-141.

## 鍋田湾における褐藻カジメの光合成特製の季節変化

Richard HAROUN・有賀祐勝・横浜康継

要旨：カジメの光合成特性の季節変化を明らかにするため、伊豆下田の鍋田湾に生育するカジメを用いて1986年4月から1987年4月まで毎月1回の測定を行った。差動式ガス検容計により、側葉の光合成速度及び呼吸速度を測定した。光合成-光曲線は測定した月により側葉ごとに異なったが、全ての側葉が新しい冬季にはほとんど同じであった。葉面積当たりでは、最も若い側葉はより古い側葉に比べて高い純光合成速度を示し、光飽和光合成速度の最高値 ( $44\sim 49 \mu\text{O}_2 \cdot \text{cm}^{-2} \cdot \text{h}^{-1}$ ) は初春に、最低値 ( $19\sim 31 \mu\text{O}_2 \cdot \text{cm}^{-2} \cdot \text{h}^{-1}$ ) は秋季(生殖期)に見られた。乾燥重量当たりでは、光飽和光合成速度は側葉の厚さと逆の関係にあり、最高値は第2側葉で、最低値は第11側葉で得られた。クロロフィル  $a$  当りでは、乾燥重量当りの場合と同様の傾向が認められたが、光飽和光合成活性はそれぞれ大きな季節変化を示さなかった。第2側葉以外の各側葉の呼吸速度は年間を通して安定していたが、第2側葉では側葉の形成期にあたる11月及び2月に高い極大値がみられた。カジメの光合成は、その生育過程と密接に関連している。カジメの葉状部は、それを取りまく水中の光環境に応じて色素濃度を調節している。

## Colors of submerged objects observed from a viewpoint above the sea surface\*

Tsutomu MORINAGA\*\*, Hisayuki ARAKAWA\*\*, Hiroo SATOH\*\*  
and Kanau MATSUIKE\*\*

**Abstract:** In order to understand the quantities of marine resources and control the properties of sea waters by means of the optical measurements above the sea surface, such subjects that chromatic differences of sea waters in different sea regions and the reasons why those differences are brought forth, chromatic shiftings of colors of the submerged objects observed from a viewpoint above the surface; and depth limitations of discriminating colors of the submerged objects from colors of sea waters were analyzed through the *in situ* oceanographical surveys and indoor experiments as well.

(1) The CIE colorimetric system defines color of water, in terms of chromatic nomenclature, to be "dark Purplish Blue" of which dominant wavelength is 474nm in the Bay of Bengal, "dark Blue" of 480nm in the Bay of Sagami, "dusky Olive Green" of 554nm in the entrance district of Tokyo Bay, and "dark Olive" of 580nm in the interior part of Tokyo Bay. Colors of sea waters are different in localities, of which the largest cause is a difference in quantities of organic suspended substances among different sea regions.

(2) Original color of a colored board seen in the air shifts to different color due to turbidities caused by suspended matters and dissolved substances. For examples, all of blue color of which dominant wavelength is 480nm, green color of 514nm and red color of 597nm seen in the air shift to hues, each of 477, 483 and 478nm when they are submerged into clear water locating in 20m deep in the Bay of Bengal of which degree of turbidities is more or less  $0.11\text{m}^{-1}$ . Those hues are, in turn, going to be converged into an identical color of sea water itself of which dominant wavelength is 474nm, as the depth of water increases.

(3) Depth limitations of discriminating, with naked eye, each aerial color of the colored boards mentioned above from colors of sea waters themselves are 13.4m for blue, 12.0m for green, and 9.1m for red in clear water of the Bay of Bengal, and 0.9m, 0.8m, and 1.0m for each color in muddy water of the interior part of Tokyo Bay, of which degree of turbidities is more than  $4.6\text{m}^{-1}$ .

(4) Depths of water, within which any submerged objects could be visually recognized from a viewpoint above the surface, substantially vary with colors of the submerged objects and degrees of turbidities of sea waters. Besides, aerial color of a submerged object, which registers the maximum depth of discriminating such color from color of sea water, is quite similar to color of sea water itself.

### 1. Introduction

In recent years, the attempts of obtaining information on submerged objects by means of the remote sensing the wavelength distributions as well as the intensities of light returned back out of the sea into the air were carried on with the aid of satellites and aeroplanes. For example,

\* Received June 8, 1992

\*\* Tokyo University of Fisheries, Konan 4-5-7, Minato-ku, Tokyo, 108 Japan.

LAURS *et al.* (1984) and STRETTA (1988) intended not only to determine the quantities of tuna resources in fishing grounds off the coast of California and the west coast of Africa as well but also to monitor the life and growth of coral reefs along the east coast of Australia by way of processing the image transmitted from a satellite.

The problems required to be solved in advance of developing of this remote sensing system and

putting it in practical use can be classified into such three items as follows, (1) What is the relation between underwater physical structures including suspended substance distributions and upward radiance distributions in the area near the surface? (2) How to make correction of an attenuation amount of each beam having a different wavelength while it is transmitted from the sea surface to a satellite or aeroplane? (3) Technology of image processing for a variety of information obtained through the detector on the satellite or aeroplane. Lately the requirements of Item 2 and 3 mentioned above have been developed fairly well so that the remote sensing system of the temperature distribution of the sea surface has been succeeded to put it to practical use. The requirement of Item 1, however, have been considerably delayed in progress.

With respect to the relation between the chlorophyll concentration in the water just below the surface and the upward spectral radiance in the area near the surface, GORDON *et al.* (1983) and KIM *et al.* (1980) introduced their own equations based on the data acquired by the water color scanner (CZCS, Coastal Zone Color Scanner; OCS, Ocean Color Scanner) of Satellite NIMBUS 7 and Space Shuttle as  $C=1.13 (L_{443}/L_{550})^{-1.71}$  ( $C < 1.5 \text{ mg m}^{-3}$ ) and  $C=3.26 (L_{520}/L_{550})^{-2.439}$  ( $C > 1.5 \text{ mg m}^{-3}$ ); and  $C=5 \exp(-5.44 R)$ , respectively, where  $C$  stood for the quantity of chlorophyll;  $L_{443}$ ,  $L_{482}$ ,  $L_{520}$ ,  $L_{550}$ , and  $L_{552}$  denoted the upward radiances of which wavelength were 443, 482, 520, 550, and 552nm, respectively; and  $R$  indicated the formalized radiance differential such as  $R=(L_{482}-L_{552})/(L_{482}+L_{552})$ . However, even if these equations are applied to the circumstances in the different oceanic waters, the results brought about may not be satisfactory enough to justify the relations among  $C$ ,  $L$  and  $R$ . It seems to be such a reason that the quality and quantity of suspended sediments as well as plankton considerably vary with localities. VERTUCCI and LIKENS (1989) surveyed a lake in Adirondack Mountain to grasp an acidified extent of the water and collected a number of measurements in respect to the reflected spectral irradiance on the lake surface and the parameter indicating the quality of water such as DOC (Dissolved Organic Carbon), the total amount of pigment, the turbidity, pH, etc. As a

result, they could make success to classify spectral distribution modes of reflected irradiance into five typical kinds, but failed to find any acidification of water which was attributed to the correlation between the distribution mode of irradiance and the parameter.

The object of this study is to understand quantitatively marine resources and control properties of sea water through optical measurements obtained from the water just below the surface. In order to achieve such object, the following three subjects must be carefully investigated.

1. Colors of water varied with localities and the reasons why such differences in color are brought forth.
2. Chromatic shiftings of colors of submerged objects observed from a viewpoint above the surface.
3. Depth limitations of discriminating colors of submerged objects from colors of waters.

## 2. Method

### 2-1 *In situ observations*

On board of the T/V Seiyō-maru and the Shinyō-maru as well of Tokyo University of Fisheries, the practical observations for this study were taken place on 6 different occasions such as in June 1984, April 1985, June 1985, June 1986, February 1987 and June 1987. The objective waters of the surveys were the interior part of Tokyo Bay, the entrance of Tokyo Bay, the Bay of Sagami and the Bay of Bengal in the Indian Ocean; where the interior part of Tokyo Bay denoted the northern region of a line connecting Futtsu with Kannonzaki, the entrance district of Tokyo Bay stood for the region between a line connecting Futtsu with Kannonzaki and a line connecting Sunosaki with Jyogashima, the Bay of Sagami designated the region extended westward from a line connecting Sunosaki with Jyogashima up to the Izu Peninsula, and the Bay of Bengal denoted the region between Lat.  $9^{\circ}$  to  $12^{\circ}$  N along the line of Long.  $87^{\circ}$  E. The number of observation stations throughout those regions were counted 23 in total (Fig. 1).

In those observations, the downward spectral irradiance and the upward spectral radiance in the area near the sea surface, the upward spectral radiance of submerged objects and the

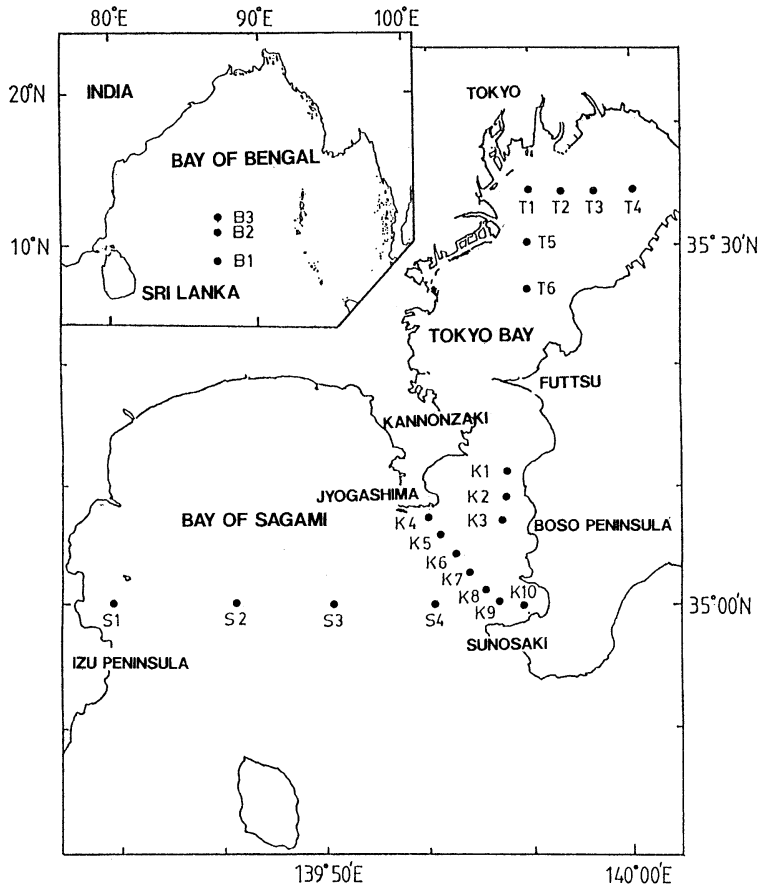

Fig. 1. Observation stations at four sea regions. The number of stations throughout those regions is counted 23 in total.

environmental factors of oceanic water are measured. For the measurements of those spectral radiances and irradiances, the Ocean Color Spectral Meter (OCSM)\* was employed (KISHINO *et al.*, 1983; MATSUIKE *et al.*, 1985; FU and MORINAGA, 1988). The blue, green and red color boards made of acrylic resin, each of which had a size of 0.6m × 0.6m × 0.002m, were used for the submerged objects, placing each into the water of 55cm deep. The reflectances from each color plate are exhibited in Fig. 2. The dominant wavelength for each color board was 480nm for

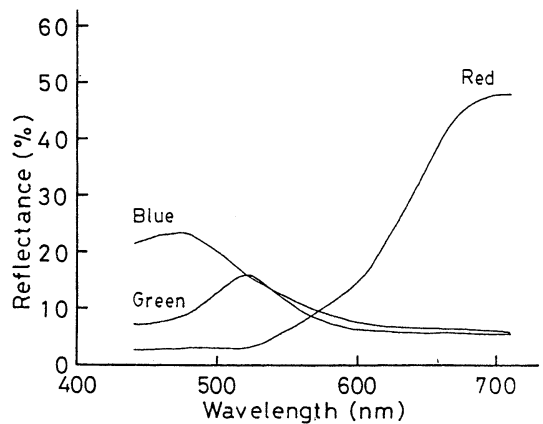

Fig. 2. Spectral reflectances from each color plate.

the blue, 514nm for the green and 597nm for the red one, respectively.

\* Remarks: The instrument, OCSM, enables to measure the upward radiance as well as the downward irradiance of such 8 wavelengths as 440, 480, 520, 550, 600, 660, 680 and 710nm of visible lights with a high accuracy and in a short time.

Such items as turbidity, spectral irradiance, water temperature, salinity, quantity of suspended matters and particle size distributions, quantity of chlorophyll, transparency and the water color were measured as the environmental factors of sea water.

The turbidity was measured by an *in situ* Martek lighth-flux transmittance meter having an optical path length of 1 m and a dominant wavelength of 486nm. The 8 spectral submarine irradiance meter of SR-8 type manufactured by Ishikawa Sangyo was applied to measure the spectral irradiance. This instrument was used with a set of 8 interference filters providing each the respective dominant wavelength of 377, 421, 481, 513, 570, 621, 653 and 677nm for the products manufactured before the year of 1985 or 443, 481, 513, 554, 599, 664, 683 and 709nm for the ones from the year of 1986 onward. As the instruments of measuring the temperature and the salinity, S-T meter of Model 620 produced by YEOKAL Electronic's were adopted. The weight of suspended particles was measured by means of the filtration method (1-20/D) using Millipore HA Filter and the particle size distributions were resulted through Coulter Counter Model ZM of which aperture size was 100  $\mu$ m. The quantity of chlorophyll contained in a certain volume of sample water was extracted by acetone after processing the water by a vacuum filtration through the glass-filter, GF/C, of Whatman, and quantitatively determined by means of the spectral light absorbancy system applying a spectral photometer. A Secchi disc, and a Forel water color meter were used to measure the transparency, and color of water, respectively.

### 2-2 Indoor experiment

An outline of the experimental apparatus equipped in the laboratory is illustrated in Fig. 3.

As seen in the sketch, a cylindrical water tank of 60cm in diameter, 60cm in depth and 200 liters in volume was used for the experiment. The inside surface of the tank was coated with black paint to avoid any reflections. A projector socketed with four bulbs of Toshiba Reflector Lamp for daylight color use, of which specifications are 100V, 500W, and 5500K in color

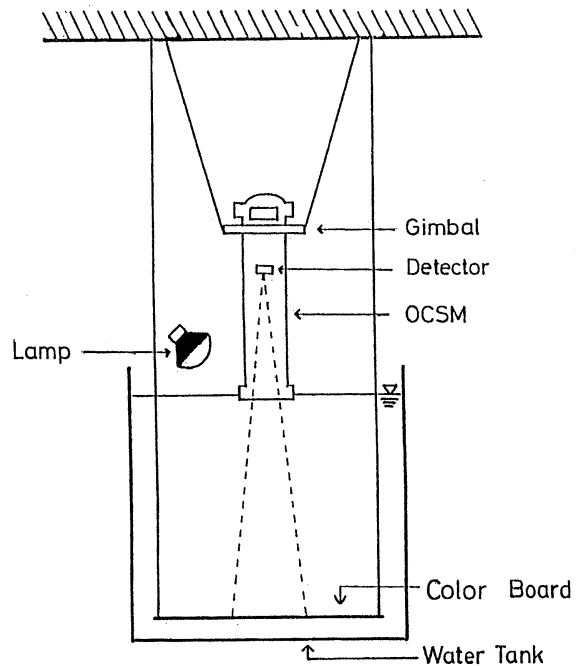

Fig. 3. Experimental apparatus.

temperature, was used for illumination, mounting it above the water tank so that the water surface could be uniformly irradiated. The tank was filled with city water strained through Millipore Filter of 1  $\mu$ m in pore size so that the water have a depth of 55cm. Then, after mixing undermentioned materials with the water so as to simulate different concentrations of suspended particles, each color disc coated with the same color as used for the outdoor survey was sunken on the bottom. And, the upward spectral radiance was measured by OCSM installed on the surface. One of clay mineral called kaolinite of which particles have an average diameter of 3.0  $\mu$ m or microcystis of phytoplankton of which average particle size is 4.0  $\mu$ m in diameter is used as the material to make simulative suspended particles. Such 4 different grades of kaolinite concentration as 1, 5, 10, and 50 mg/l and such 3 different grades of chlorophyll-a concentrations were applied to the indoor experiment.

### 2-3 Color specification

The Commission Internationale de l'Eclairage



(CIE) colorimetric system (YAMAUCHI and OMOTO, 1966) is employed for expressing colors, the color-matching functions of the energy amounts of three primary colors obtained through the human color sensation organ (i.e. human eye) are exhibited graphically in Fig.4. Such three curves shown as  $\bar{x}$ ,  $\bar{y}$ ,  $\bar{z}$  in the graph represent each of blue, green, and red color sensation. When combined each of those  $\bar{x}$ ,  $\bar{y}$ ,  $\bar{z}$  with the spectral energy,  $E(\lambda)$ , of the light, their stimulation values such as  $x$ ,  $y$ ,  $z$ , which are defined as "Tristimulus Values", can be interpreted as follows,

$$X = \int E(\lambda) \bar{x} d\lambda$$

$$Y = \int E(\lambda) \bar{y} d\lambda$$

$$Z = \int E(\lambda) \bar{z} d\lambda$$

If the sum ( $s$ ) of tristimulus values expresses as  $S = X + Y + Z$  and each value  $X$ ,  $Y$ ,  $Z$  is divided by  $S$ , such independent variables as  $x = X/S$ ,  $y = Y/S$ ,  $z = Z/S$  can be found. The rectangular coordinates ( $x$ ,  $y$ ) established with the independent variables  $x$ ,  $y$ , corresponds to a chromaticity point, and if the variable  $x$  is given on the  $x$ -axis and  $y$  is on the  $y$ -axis, the locus drawn by plotting such a point is called CIE chromaticity diagram. With reference to the quantitative expression of the color difference ( $\Delta E$ ), it is calculated by the following equation,

$$\Delta E = 600 \{ Y_1^{1/2} (\Delta S)^2 + (K/600)^2 [\Delta(Y_1^{1/2})]^2 \}^{1/2}$$

where  $\Delta S$  is  $\{(r_1 - r_2)^2 + (g_1 - g_2)^2 + (b_1 - b_2)^2\}^{1/2}$ ,  
 $Y$  is  $(Y_1 + Y_2)/2$ ,  $\Delta Y^{1/2}$  is  $Y_1^{1/2} - Y_2^{1/2}$   
 and  $K$  is 100, respectively.

### 3. Results

#### 3-1 Colors of sea waters vary with different sea regions

Each of four modes in Fig. 5 shows the upward spectral radiance distributions in the area near the surface of the different sea regions; that is to say, mode(A) exhibits those at 3 points from Stn. B1 to B3 in the Bay of Bengal, mode(B) indicates those at 4 points from Stn. S1 to S4, mode(C) gives those at 6 points from Stn. K1 to K9 in the entrance of Tokyo Bay, and mode(D) illustrates those at 6 points from Stn. T1 to T6 in the interior part of Tokyo Bay.

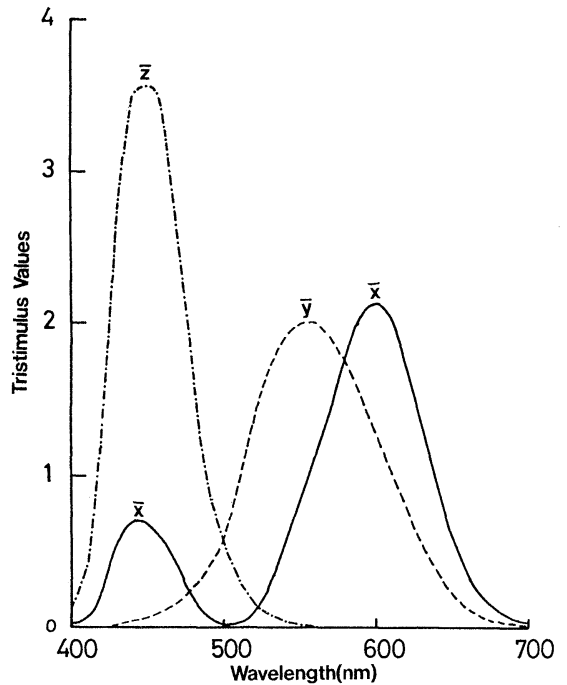

Fig. 4. CIE color-matching functions. The solid line for the values of  $x$ , the broken for  $y$ , and the one point chain for  $z$ .

The upward spectral radiance distributions in the area near the surface vary with the light intensities projected into the sea. Every practical measurement, therefore, is required to be converted into the value of the upward spectral radiance given under the conditions of a constant light quantity reached on the sea surface. Accordingly, every value of the upward spectral radiance used in the graph of Fig. 5 is the modified one obtained by means of dividing practical measurement by the downward spectral irradiance. The relevant equation for the conversion is  $Rw(0, \lambda) = Lu(0, \lambda) / Ed(0, \lambda)$ , where  $Lu(0, \lambda)$  and  $Ed(0, \lambda)$  denote each of the upward radiance and the downward irradiance in the area near the surface, and  $\lambda$  stands for the wavelength. On the other hand, the environmental factors such as the turbidity, the dried weight of suspended matters, the concentration of chlorophyll  $a$ , and the transparency resulted from the investigation in those different sea regions are listed in Table 1.

It comes to be known from Figures and Table described above that the upward spectral

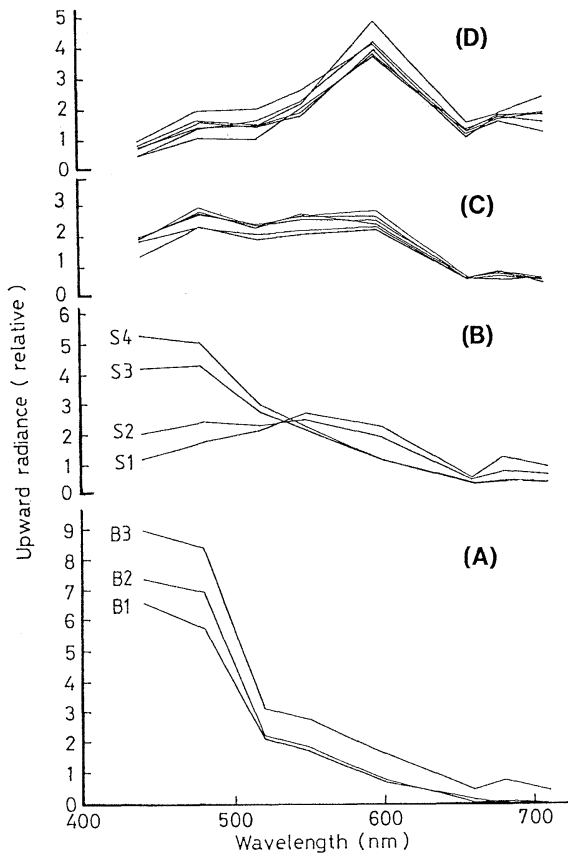

Fig. 5. Upward spectral radiance distributions at each sea region.

(A): Bay of Bengal (B): Bay of Sagami  
(C): Entrance district of Tokyo Bay (D): Interior part of Tokyo Bay

radiance distributions and the environmental factors distinctly vary with localities.

Sea water in the Bay of Bengal is so clear as to show its transparency of 33m and dried weight of suspended matters to be 0.21 mg/l. So far as

this ocean district is concerned, the shorter wavelengths the light has the more upward spectral radiance distributions it shows (refer to mode(A)); In fact, the relative values of upward spectral radiance show such a conspicuously high level as approximately 6 to 9 for the wavelength of 440nm to 480nm, but they exhibit a sharp or sudden declination for the wavelength of 480nm to 520nm while they show a moderate declination for the wavelengths of 520nm to 600nm, and they generally go down to zero, or show sometimes a local maximum for the longer wavelength band than 660nm.

In the Bay of Sagami (refer to mode(B)), the nearer the positions shift towards the Boso peninsula, the larger value of upward spectral radiance they show, and those value gradually reduces, in contrast, according to the longer band of wavelengths; but, at the positions located nearer to the Izu Peninsula, those values become smaller in the field of the shorter wavelength side of an assuming boundary considered for the wavelength of 520nm and increase, in contrast, in the field of the longer wavelength side of the boundary, and exhibit a local maximum for the wavelength of 680nm. Let us examine more in detail for the upward spectral radiance distribution at Stn. 3 located almost in a center of the Bay of Sagami. In this locality, the shorter wavelengths the light has more upward radiance for the wavelength band from 480nm decrease almost linearly and those for the longer band than do not change, keeping almost a constant level; the value at 660nm is more or less 1/25 of the largest value shown at 440nm.

The upward radiance distribution in the entrance district of Tokyo Bay shows, in contrast

Table 1. The values of turbidity, chlorophyll *a*, suspended matter and transparency at four sea regions.

Sea Region	Index	Beam Attenuation Coefficient (m <sup>-1</sup> )	Chlorophyll <i>a</i> (μg/l)	Suspended Matter (mg/l)	Transparency (m)
Bay of Bengal (Stn. B3)		0.11	0.041	0.20	33
Bay of Sagami (Stn. S3)		0.33	0.623	1.76	20
Entrance District of Tokyo Bay (Stn. K2)		1.43	5.27	2.00	6.5
Interior Part of Tokyo Bay (Stn. T1)		4.61	49.0	10.8	1.7

to the regions mentioned above, very low values for the shorter wavelength band, and maintains an almost constant distribution of which value is approximately 2 for the wide wavelength band between 440nm and 600nm (refer to mode (C)). Furthermore, the upward radiance distribution in the interior part of Tokyo Bay, of which water is considerably muddy indicating a transparency of only 1.7m and the dried weight of suspended matters to be 10.8 mg/l, shows the larger values for the shorter wavelength band, and there is a local maximum for the wavelength of 600nm (refer to mode(D)). That is to say, the values of upward radiance distribution decrease for the shorter wavelength band less than 550nm but increase for the longer wavelength and more than 550nm, indicating an exact opposite distribution mode to that in the sea region of the Bay of Bengal.

A mode of upward radiance distribution of a sea region, which is different from that of other sea regions, comes out as a specific color of water of the sea region which is different from that of the other regions. In other words, a certain color of a sea region is a reflex of a specific mode of upward radiance distribution of the sea region. People generally say that the sea is clean or beautiful when they can see blue color of the sea. They say, however, the sea is muddy when they see the sea of green to brown colors of which wavelengths are fairly longer. The CIE colorimetric system is employed to indicate quantitatively a variety of colors of the sea. A CIE chromaticity diagram\* is exhibited in Fig.6, in which colors in each sea region of the Bay of Bengal, the Bay of Sagami, the entrance district of Tokyo Bay, and the interior part of Tokyo Bay are illustrated. The nomenclatures of the sea colors at each representative observation station of those sea regions listed in Table 1 are called as "dark Purplish Blue", "dark Blue", "dusky Olive Green", and "dark Olive", and their dominant wavelengths are 474,480,554, and 580nm, respectively.

\* Remarks: A visible range of upward spectral radiance applied to the chromaticity calculation for preparing of the CIE diagram are obtained the values for the wavelengths of every 10nm by means of the Lagrange's interpolation formula through Fig. 5.

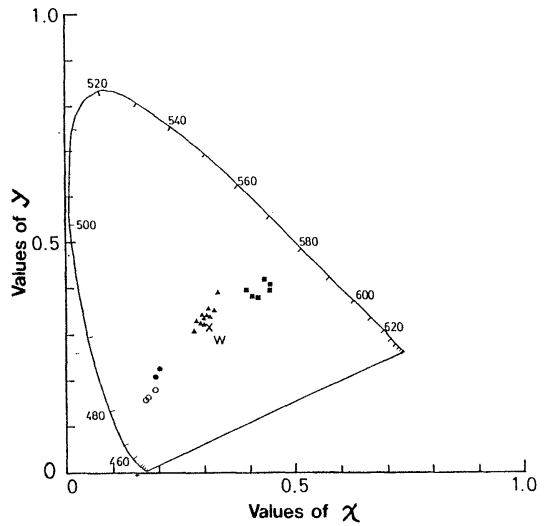

Fig. 6. CIE chromaticity diagram. The open circles for the Bay of Bengal, the solid circles for the Bay of Sagami, the triangles for the entrance of Tokyo Bay, the rectangles for the interior, and symbol W for white point.

### 3-2 Relations between colors of the sea water and quantities of suspended substances

The relations between colors of the sea and quantities of suspended substances are going to be discussed in this Chapter. The dried weights of suspended matters, the quantities of chlorophyll *a*, and the degrees of turbidities of water are selected as the indexes of representing the quantities of suspended substances. Each relation between the dominant wavelengths for colors of sea waters and each of the dried weights of suspended matters, the quantities of chlorophyll *a*, and the degrees of turbidities in the aforementioned 4 different sea regions is exhibited in each diagram of Figs. 7, 8, & 9, respectively; where the vertical axis of each diagram shows one of the dried weights of suspended matters, the quantities of chlorophyll *a*, and the degrees of turbidities, respectively. It comes to be learned through those diagrams that every sea region has a close but different correlation between the dominant wavelengths of colors of the sea and each of the indexes mentioned above. For example, the dried weights of suspended matters vary with the sea regions, exhibiting 0.28 in the Bay of Bengal and the Bay of Sagami 0.02 in the entrance district of Tokyo Bay, and

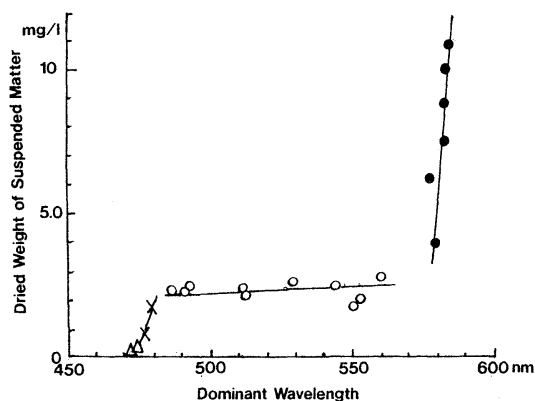

Fig. 7. Relation between the dominant wavelengths for colors of sea waters and the dried weight of suspended matter. The triangles for the Bay of Bengal, the crosses for the Bay of Sagami, the open circles for the entrance of Tokyo Bay, and the solid circles for the interior of Tokyo Bay.

0.74 in the interior part of Tokyo Bay.

The suspended matters, in general, consist of organic and inorganic substances. As described in the preceding Chapter, the absorptions by organic substances suspended in water vary with the wavelengths of underwater spectral lights, but inorganic substances do not absorb any light. Both the organic and the inorganic substances, however, would scatter underwater lights without relating to any wavelengths. Accordingly, the relation between colors of the sea and the quantities of organic suspended substances is different from the relation between colors of the sea and quantities of inorganic suspended substances. To confirm quantitatively such a difference, a series of experiments are conducted by the use of chlorophyll *a* as an organic substances and kaolinite as an inorganic substances in the laboratory. Thus, the relations between wavelengths exhibited on the horizontal axis and relative upward radiances in the area near the surface given on the vertical axis under different concentrations of kaolinite and chlorophyll *a* are shown in a diagram of Fig.10. As seen in this figure, the values of upward radiances for all over wavelengths under the 50 mg/l concentration of kaolinite as the inorganic substance almost 9 times as much as those in the case of clean filtrated water without any suspended substances. The upward radiances under

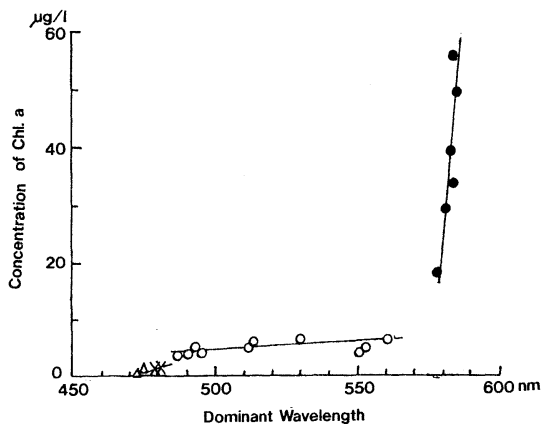

Fig. 8. Relation between the dominant wavelengths for colors of sea waters and the quantities of chlorophyll *a*. The symbols are same as in Fig. 7.

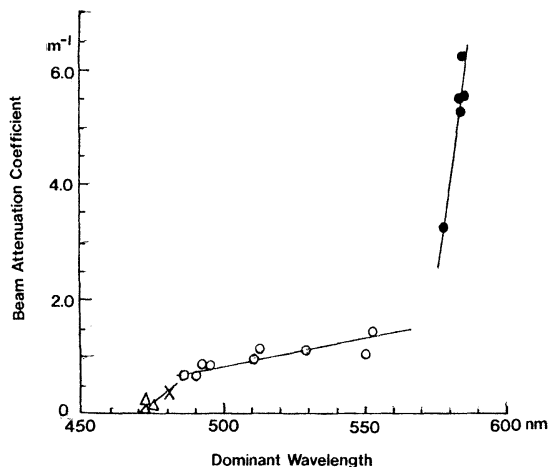

Fig. 9. Relation between the dominant wavelengths for colors of sea waters and the degrees of turbidities. The symbols are same as in Fig. 8.

the 285  $\mu\text{g/l}$  concentration of chlorophyll *a* as the organic substance abruptly decrease their values for the shorter wavelength band less than 520nm. A CIE chromaticity diagram to show the relations between colors of the waters and both organic and inorganic suspended substance is shown in Fig.11. In the course of examining those diagrams, it is learned with interest that there is a wide difference between the upward radiance distributions in the water suspended with inorganic substances and those in the water

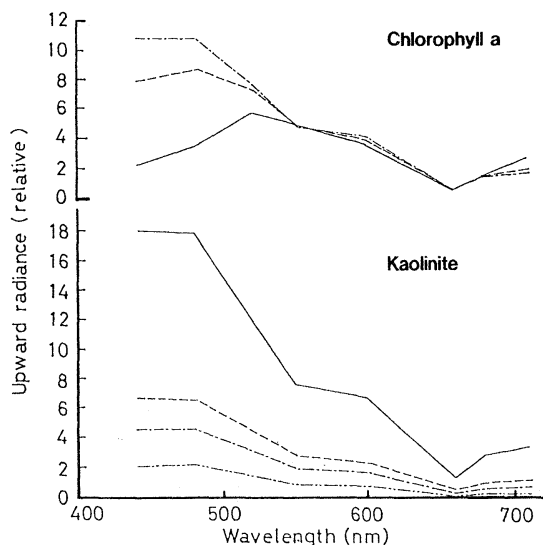

Fig. 10. Upward spectral radiance distributions under different concentrations of kaolinite and chlorophyll *a*. Kaolinite: The solid line for filtered sea water, the broken for 5mg/l, the one point chain for 10mg/l and the 2 point chain for 50mg/l. Chlorophyll *a*: The solid line for 285 µg/l, broken for 45 µg/l, and the one point chain for 3.5 µg/l.

suspended with organic substances; that, in case of the water suspended with inorganic substances, colors of the waters do not change at all (dominant wavelengths: 478→476nm) even if increasing their concentration; that, under such circumstances that the water is suspended with organic substances, colors of the waters make a great change with their concentration (dominant wavelengths: 478→549nm). It can be analogically interpreted through these results of the experiments that organic suspended substances exert more influence on colors of the sea than any inorganic substances.

3-3 Chromatic shiftings of colors of submerged objects observed above the sea surface

Colors of any objects submerged into sea water when observed from a viewpoint above the surface can be considered to vary with colors of water themselves and submerged depths of water as well.

Fig.12 shows colors of the colored boards submerged at the depth of 55cm in the Bay of Bengal and the entrance district as well as the

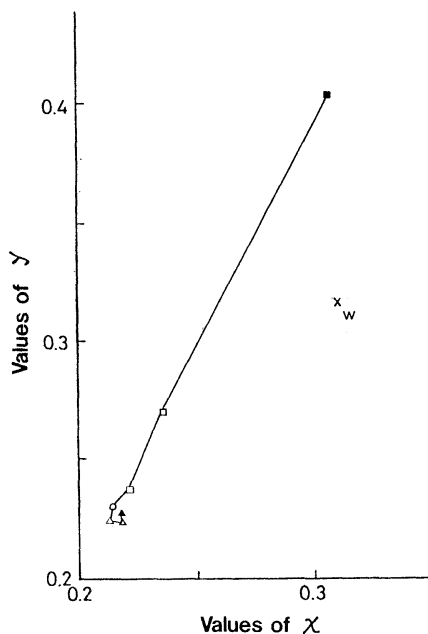

Fig. 11. Relation between colors of the waters and both organic and inorganic suspended substances shown in CIE chromaticity diagram. The open circles for filtered sea water, the triangles for inorganic substance, the rectangles for the organic substance, and symbol W for white point.

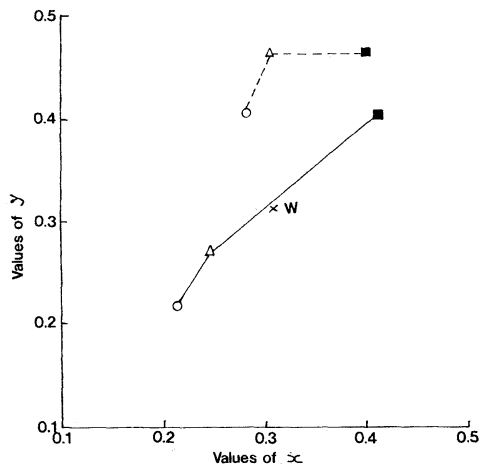

Fig. 12. Chromatic shiftings of colors of the colored boards submerged at the depth of 55cm in each sea region. Symbols  $\circ$ ,  $\triangle$  and  $\blacksquare$  show the color of board, blue, green, and red, respectively. The solid line for Bay of Bengal, the broken for the entrance of Tokyo Bay, and the one point chain for the interior part of Tokyo Bay.

interior part of Tokyo Bay, in which sea water colors are considerably different one another. It can be confirmed through the diagram of Fig.12 that an original color of each colored board submerged in a depth of 55cm is orderly shifted to the different colors according to the chromatic effects of different sea waters. That is to say, the diagram shows that a blue board submerged in the Bay of Bengal is seen with color of "dusky Purplish Blue" (dominant wavelength: 476nm) in terms of the chromatic nomenclature, and this color shifts to "dusky Olive" (dominant wavelength: 579nm) in the interior part of Tokyo Bay; similarly, "very dark Green" (529nm) of a green board to "dark Olive" (570nm), and "dark Yellowish Brown" (595nm) to "dark Green Brown" (591nm); besides, if the original color of the submerged board belongs to one of shorter wavelengths, it shifts to one of colors of the longer wavelengths, and an original color of the submerged board belongs to one of the longer wavelengths, it shifts to one of shorter wavelengths, and all those colors converge in the proximity of "dark Olive" (dominant wavelength: 570nm to 582nm). This suggests that such chromatic shiftings has a certain relation with turbidities of water.

A series of experiments were conducted in the laboratory to quantitatively confirm the chromatic shiftings more in detail for the object submerged into the depth of 55cm in turbid waters having different concentrations of inorganic substances and organic substance as well. Fig.13 shows how underwater colors of different colored discs vary with turbidities of waters, where the solid line stands for inorganic suspended substances and the broken line denotes organic suspended substances. As seen, in case of the water suspended with inorganic substances, all the colors of every submerged colored disc converge into "dark Blue" in terms of the chromatic nomenclature. In case of the water suspended with oranic substances, underwater colors of the blue and the green colored disc shift toward colors of the longer wavelength band, and underwater color of the red colored disc shifts slightly towards color of one of shorter wavelength band, and all these colors seems to converge into "Yellow". In conse-

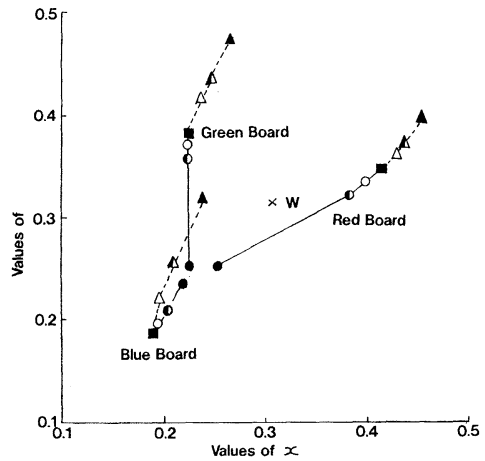

Fig. 13. Chromatic shiftings of colors of the colored boards in turbid water having different concentrations of organic and inorganic substances. The solid line for inorganic substance, the broken for organic substance, and when submerged into a depth of 55cm.

quence, it is understood that chromatic shiftings of underwater colors for any submerged objects observed from a viewpoint above the sea surface vary with not only the properties of substances which cause turbidities of water but also the mixing ratios of organic substances to inorganic substances.

In the next place, chromatic shiftings of underwater colors with the depths of sea water are examined. Because of insuperable difficulties to solve this problem by in-situ surveys or experiments in the laboratory, it is intended, as a solution, to induce an arithmetic formula which enables to obtain theoretically underwater colors of submerged objects. For this purpose, the study is developed by the use of the irradiance instead of the radiance in the following discussions.

It is assumed that the upward spectral irradiance,  $E_u(0, \lambda)$ , in the area near the surface of a colored board when it is submerged in a depth,  $Z$ , can be expressed by the sum of the irradiance,  $E_{ub}(0, \lambda)$ , originated by the reflection from the colored and the irradiance,  $E_{uw}(0, \lambda)$ , originated by the scattering from the water, as shown by the following equation

$$E_u(0, \lambda) = E_{ub}(0, \lambda) + E_{uw}(0, \lambda) \dots\dots\dots(1)$$

$E_{ub}(0, \lambda)$  of the first term of the equation (1)

is expressed as follows,

$$Eub(0, \lambda) = Ed(0, \lambda) \cdot Rb(\lambda) \cdot \exp[-2 \cdot K(\lambda) \cdot Z] \dots\dots(2)$$

where  $Ed(0, \lambda)$  stands for the downward spectral irradiance just under the sea surface,  $Rb(\lambda)$  for the spectral reflectance of the submerged colored board,  $K(\lambda)$  for the irradiance attenuation coefficient,  $Z$  for the depth of sea water, and  $\lambda$  for the wavelength. The irradiance,  $Euw(0, \lambda)$ , in the second term of the equation (1) is the one by subtracting the upward irradiance,  $Euw(z-\infty, \lambda)$ , brought from the deeper water than the depth of  $z$ , in which the board is located,  $Euw(0-\infty, \lambda)$  under conditions of not existing any board. The irradiances,  $Euw(0-\infty, \lambda)$  and  $Euw(z-\infty, \lambda)$ , can be expressed as follows,

$$Euw(0-\infty, \lambda) = Ed(0, \lambda) \cdot Rw(\lambda),$$

where  $Rw(\lambda)$  denotes the irradiance ratio.

$$Euw(z-\infty, \lambda) = Ed(0, \lambda) Rw(\lambda) \exp[-2 \cdot K(\lambda) \cdot z]$$

But, since  $Euw(0, \lambda)$  is equal to  $Euw(0-\infty, \lambda) - Euw(z-\infty, \lambda)$ ,

$$Euw(0, \lambda) \text{ will be } Ed(0, \lambda) \cdot Rw(\lambda) \cdot [1 - \exp[-2 \cdot K(\lambda) \cdot Z]] \dots\dots(3)$$

Subsequently, if the equations (2) and (3) are substituted into the equation (1),  $E_u(0, \lambda)$  will be equal to

$$Ed(0, \lambda) \cdot Rb(\lambda) \cdot \exp[-2 \cdot K(\lambda) \cdot Z] + Ed(0, \lambda) \cdot Rw(\lambda) [1 - \exp[-2 \cdot K(\lambda) \cdot Z]] \dots\dots\dots(4)$$

The chromatic shiftings of colors of the colored boards submerged in a depth of 55cm, which are induced by aid of the equation (4) are exhibited in Fig.14. It should be noted here that the variable,  $Rb(\lambda)$ , stands for the relative values of reflectances shown in Fig.2 and the variable,  $Rw(\lambda)$ , denotes those of upward spectral radiances; that, taking an illustration of a case for the wavelength of 440nm, the attenuation coefficients of irradiances are  $0.037m^{-1}$  in the Bay of Bengal and  $2.14m^{-1}$  in the interior part of Tokyo Bay; that the solid line stands for the chromatic shifting of the blue board, the broken line for the green board, and the one point chain

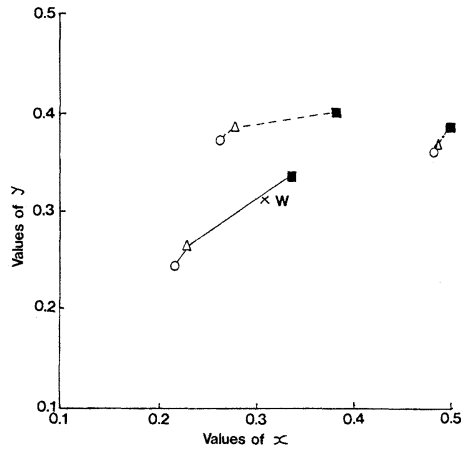

Fig. 14. Chromatic shiftings of colors of the colored boards submerged in a depth of 55cm through numerical computation. The symbols are same as in Fig. 12.

line for the red board; and each symbol such as  $\circ$ ,  $\triangle$  and  $\blacksquare$  represents the Bay of Bengal, the entrance district of Tokyo Bay, and its interior part, respectively. It can be learned through the diagram that colors of the blue and green board shift towards the longer wavelength band while those of red board slightly shifts towards the shorter wavelength band as the depth increases, and they finally converge into "dark Yellowish Brown" (dominant wavelengths: 582 to 589nm). It may be worth describing that the results induced from the aforementioned assumption almost coincide with every practical measurement of different sea regions introduced in Fig.12. Therefore, the equation (4) is reasonable enough to use it for the computing a fairly good approximation of chromatic shiftings of colors of any submerged objects.

3-4 Depth limitations of discriminating colors of submerged objects from colors of sea water

Chromatic shiftings of colors of submerged objects caused by colors or turbidities of sea waters themselves, which are observed from a viewpoint outside the sea surface, having been discussed in the preceding chapter. In this chapter, however, the limits in depth of sea water, within which colors of the submerged board could be discriminated from colors of waters themselves when observed from a viewpoint above the surface are going to be discussed. In

order to accomplish the purpose, it is needed to recognize the human eye's threshold of color stimulus as an instrument of color sensation within which a color difference,  $\Delta E$ , between two colors can be discriminated one after another. The capacity of color difference of a secchi disc, of which complete dispersion body has the reflectance of 82%, in a certain depth is regarded as the threshold of color stimulus in this study. For example, the value of color difference,  $\Delta E$ , in the Bay of Bengal which had a transparency of 33m was 639 and that, in the interior part of Tokyo Bay which had a transparency of only 1.7m was 207, respectively.

Based on the way of thinking mentioned above, the depth limitations of color discrimination for each blue, green, and red board are obtained as 13.4m, 12.0m, and 9.1m in the Bay of Bengal of which water has a turbidity of  $0.15\text{m}^{-1}$ , and as 0.9m, 0.8m, and 1.0m in the interior part of Tokyo Bay of which has a turbidity of more than  $4.6\text{m}^{-1}$ , respectively. It may be said therefore, that such depth limitations substantially vary with different turbidities, and the depths of discrimination shows its maximum value when the color of board holds an excellent approximation to color of sea water.

#### 4. Discussion

A typical mode of upward radiance distribution for each of 4 different sea regions stated before is selected and put together in a diagram of Fig.15 so that the characteristics of upward radiance distributions in those regions can be more clearly understood, where the solid line shows the upward radiance distribution mode in the Bay of Bengal; the broken line denotes that in the Bay of Sagami; the one point chain line indicates that in the entrance district of Tokyo Bay; and the two point chain line stands for that in the interior part of Tokyo Bay. The differences in the upward radiance distribution modes among those localities are caused by the different optical properties of those sea waters. In the course of discussing the colors of the sea, optical properties can be divided into such manners as the absorption and scattering by sea water itself, those by the suspended matters and the absorption by the dissolved organic substances. Since the scattering by water itself is inverse to

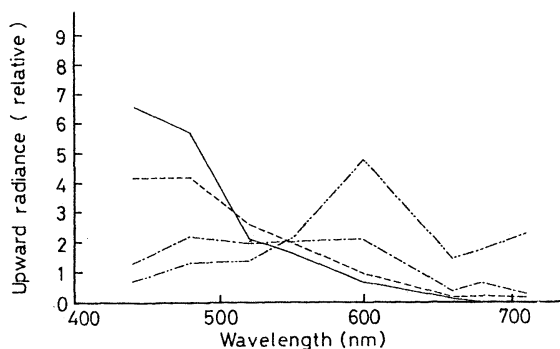

Fig. 15. Typical modes of upward radiance distribution. The solid line for the Bay of Bengal, the broken for the Bay of Sagami, the one point chain for the entrance district of Tokyo Bay, and the 2 point chain for the interior part of Tokyo Bay.

the fourth power of the wavelength, it shows the very high values for the shorter wavelength band. The scattering by the suspended matters, is almost constant for the shorter as well as the longer wavelength band, and the scattering coefficient is in proportion to the total cross-sectional area. The absorption by water itself shows the larger values for the longer wavelength band while the absorption by the suspended matters and dissolved organic substances exhibits the very high values for the shorter wavelength band. (JERLOV, 1976).

Since the optical property of sea water in each region can be considered as integration of the outcomes described above, the different modes of upward radiance distribution among those different sea regions are examined more in detail as started below. In case of the sea region of the Bay of Bengal of which water is very clear, the scattering of light by water itself, therefore, are carried on extensively so that its upward radiance for the shorter wavelength band shows the exceptionally high value compared with those of other sea regions. In other sea regions, however, due to turbidities increasing in order of the Bay of Sagami, the absorption of lights having shorter wavelengths by suspended matters and dissolved substances is so intensive that the upward radiance distributions may abruptly decrease. As seen in the diagram of Fig.8, the upward radiance distribution shows high values for the wavelengths of more or less 600nm in the sea region like Tokyo Bay in



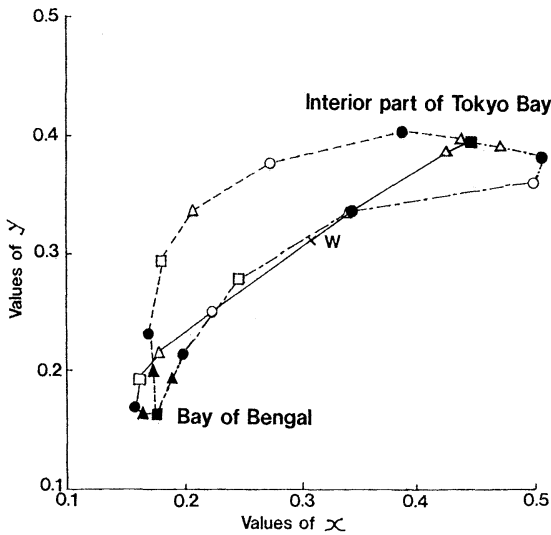

Fig. 16. Chromatic shiftings of colors of the colored boards in different depths through the computation. The solid line for the blue colored board, the broken for the green, and the one point chain for the red.

which water is muddy enough. This is considered to be caused by the scattering developed with the increased quantities of suspended particles. As a result, it can be said through the discussion described above that the optical property of each sea region clearly attributes to the peculiar mode of the upward radiance distribution in the area near the surface.

KINNEY *et al.* (1967) introduced a study on visibility of colors of submerged objects in different sea regions. They reported that chromatic shifting of color of an object submerged in water of the Thames is quite different from that in the Gulf of Mexico; that a wide shifting in wavelengths of colors was taken place in the muddy water of the Thames while it was slight in the clean water of the Gulf of Mexico. It acquires an interest that the results of their study coincide with the authors' views.

Fig. 16 shows the chromatic shiftings of colors of each submerged board obtained through the computation by aid of equation (4). For example, in case of the Bay of Bengal, each aerial dominant wavelength of which the blue, the green, and the red board is 480, 514, and 597nm will shift 477, 483, and 478nm, respectively, when each is submerged in the depth of 20m.

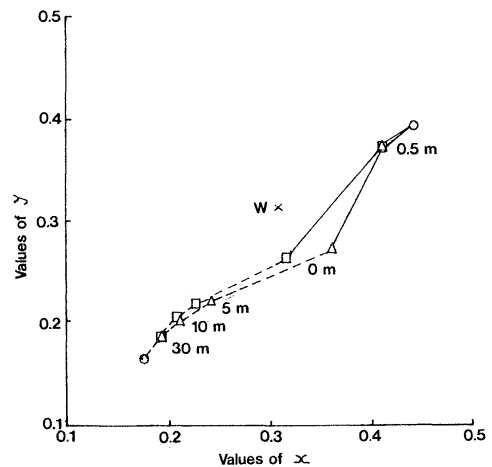

Fig. 17. Chromatic shiftings of colors of tuna's body in different depths. The broken line for the Bay of Bengal, and the solid for the interior part of Tokyo Bay. Two open circles stand for the colors of sea water in two sea regions. Symbols  $\Delta$  and  $\square$  show the color of yellow-fin tuna's body, and that of big-eye tuna's body, respectively.

Furthermore, the chromatic shifting rates of colors of blue board vary with its submerged depths of water, and such rates in the Bay of Bengal are larger than those in the interior part of Tokyo Bay. In consequence, it can be understood that aerial color of the board gradually shifts to color of sea water itself as the depth of water increases.

It draws interest that the those values of depth limitations of discriminating colors resulted from the study herein coincide with the practical measurements obtained by KINNEY *et al.* (1967, 1969). They practically observed the submerged the submerged different-colored targets. As a result, they could visually recognized that such a color order as yellow, blue, green, orange, and red in the clear water shifted to such an order as yellow, orange, red, green, and blue in the muddy water.

In the course of the subject discussing in this section, it may be worth considering the depth limitation of color discrimination for the body of fish instead of the colored board. Tuna species are selected as objects for the study (MORINAGA *et al.*, 1990). Based on the spectral reflected radiances of tuna measured soon after

the catch in the sea region of the Bay of Bengal, the distribution of those measurements in relation to their wavelengths are examined in such way that, as for big-eye tuna, said radiances keep almost constant for all over the wavelengths except a range of 520nm to 550nm in which they have a minimum distribution; that for yellow-fin tuna, they show a minimum distribution also in the range of 520nm to 550nm, and increase their distributions for the longer wavelength band than 550nm, exhibiting a local maximum for 660nm of which degree is approximately 2 or 3 times as much as the distribution for 550nm. The color of yellow-fin tuna's body is found to be "very dusky Red Purple" (complementary wavelength: 501nm) in terms of chromatic nomenclature, and that of big-eye tuna's body is to be "Purplish Black" (complementary wavelength: 543nm).

Fig.17 shows how to shift colors of tuna's body in relation with depths and turbidities of water. As seen in the diagram, chromatic shiftings of colors of tuna's body vary with depths and turbidities, and like the case of the colored board mentioned above, they come similar to respective water color of each sea region as the depth of water increases. The depth limitations of discriminating color of tuna's body from color of water in different sea regions are obtained, by the same way as the case of the colored board, as 6.1m in the Bay of Bengal and 0.5m in the interior part of Tokyo Bay. The values of such limitations are widely different one another in localities, but they are little different in species of tuna.

#### Acknowledgements

The authors would like to express our deepest appreciation to Mr. T. TAKAHASHI, Associate professor of Tokyo University of Fisheries, Mr. N. OKAMI, Scientist of Institute of Physical and Chemical Research, Ret., and Dr. K. HISHIDA, Professor of Oceanography Department, Tokai University, Ret., for their valuable assistances in preparing the manuscript.

#### References

- FU, K. and T. MORINAGA (1988): Correlations of upward spectral radiance near the sea surface and turbidity of water in Tokyo Bay. *J. Tokyo Univ. of Fish.*, **75**(2), 201-212.
- GORDON, H. R., D. CLARK, J. W. BROWN, O. B. BROWN, R. H. EVANS, and W. BROENKOW (1983): Phytoplankton pigment concentrations in the Middle Atlantic Bight; comparison of ship determinations and CZCS estimates. *Applied Optics*, **22**, 20-36.
- JERLOV, N. G. (1976): *Marine optics*. Elsevier Scientific Publ. Comp. Amsterdam.
- KIM, H. H., C. R. MCCLAIN, L. R. BLAINE, W. D. HART, L. P. ATKINSON and J. A. YODER (1980): Ocean chlorophyll studies from a U-2 aircraft platform. *J. Geophys. Res.*, **85**, 3982-3990.
- KINNEY, J. A. S., S. M. LURIA and D. O. WEITZMAN (1967): Visibility of colors underwater. *J. Opt. Soc. Am.* **57**(6), 802-809.
- KINNEY, J. A. S., S. M. LURIA and D. O. WEITZMAN (1969): Visibility of colors underwater using artificial illumination. *J. Opt. Soc. Am.* **59**(5), 624-628.
- KISHINO, M., S. SUGIHARA and N. OKAMI (1983): Ocean color spectrum meter (OCSM) for remote sensing study. *J. Remote Sensing Soc. Japan*, **3**(2), 13-20.
- LAURS, R. M., P. M. FIEDLER and D. R. MONTGOMERY (1984): Albacore tuna catch distributions relative to environmental features observed from satellites. *Deep-Sea Res.*, **31**, 1085-1099.
- MATSUIKE, K., T. MORINAGA and T. MIYAZAWA (1985): Studies in oceanic remote sensing I. The relationship between upward spectral radiance near the sea surface and the suspended matter quantity, quality and existing depth. *J. Tokyo Univ. of Fish.*, **72**(2), 111-125. (in Japanese).
- MORINAGA, T., T. KOIKE and K. MATUIKE (1990): Underwater visibility of a branch line of longline gear to tuna in the bay of Bengal. *La mer*, **28**(2/3), 117-122. (in Japanese).
- The Illuminating Engineering Institute of Japan (1987): Measurements of light. *Nihonriko shhupankai* (in Japanese).
- STRETTA, J. M. (1988): Forecasting tuma fisheries area: what parameters, what models? The praxeological response. The second French Japanese Symposium of Oceanography, Shimizu. Japan.
- VERTUCCI, F. A. and G. E. LIKENS (1989): Spectral reflectance and water quality of Adirondack mountain region lakes. *Limnol. Oceanogr.*, **34**(8), 1656-1672.
- YAMAGUCHI, J. and G. OMOTO (1966): *Handbook of color science*. Association of color science, Nankodo (in Japanese).

## 海面上から見た水中物体の色

森永 勤・荒川久幸・佐藤博雄・松生 治

要旨：海中資源量の把握と水質管理を海面上の光学的物理量の測定より行うことを目的として、海の色と海域による相違とその原因、海面上から見た水中物体の色の移動、及び水中物体の色と海の色との判別水深を、海洋の現場観測と室内実験の双方から解析した。

(1) C I E 表色系による海の色名はベンガル湾で「dark purplish blue(主波長：474nm)」, 相模湾で「dark blue(480nm)」, 東京湾口部で「dusky olive green (554nm)」及び東京湾奥部で「dark olive(580nm)」である。このように海の色は海域によって異なり、その相違は主に海中の有機懸濁物量の差に起因していると言える。

(2) 海面上から見た水中色彩板の色は水深や海水の濁り（懸濁物や溶存物に起因する）で変化する。例えば、清澄な海水（濁度： $0.11\text{m}^{-1}$ ）のベンガル湾の水中 20m 深では、空中で青色（主波長：480 nm）、緑色（514nm）及び赤色（597nm）を呈する色彩板の各色は477,483及び478nmの各主波長の色に移動する。深度が増大して、究極的にはベンガル湾の海の色（474nm）自身に収束する。

(3) 上記の色彩板の各色（空中）と海の色との差を肉眼で判別する限界水深は、清澄な海水のベンガル湾でそれぞれ 13.4, 12.0 及び 9.1m、濁った海水（濁度： $>4.6\text{m}^{-1}$ ）の東京湾奥部でそれぞれ 0.9, 0.8 及び 1.0m である。

(4) 海面上から見て水中物体を視認し得る深さは、物体の色や海水の濁りで大きく異なる。又、その判別水深の最大値を示す物体の色（空中）は海の色に類似した色彩である。

# Laplace の tidal equation の解 (東西方向に zonal でない場合の解法: continued fraction による収束性) について\*

松島 晟\*\*・古賀 雅夫\*\*

## On the solution of Laplace's Tidal Equation (The convergence of the solution by the continued fraction method in the non-zonal case towards the east)

Akira MATSUSHIMA \*\* and Masao KOGA \*\*

**Abstract:** In the previous works, we studied on the convergence of the solution by the continued fraction method proposed by HOUGH in the zonally symmetric case. There are three methods for solving Laplace's tidal equation using continued fraction when it is not zonally symmetric. In the present paper, we studied on one of the three methods. Generally speaking, this method was not so good. From the results of the calculations done here, however, the following were found.

- i) The convergence of the solution becomes better as the angular frequency becomes larger.
- ii) As the difference between  $n$  and  $k$ , where  $n$  is the wave mode towards the south and  $k$  is the wave number towards the east, becomes larger the convergence of the solution becomes worse. On the other hand, when  $(n-k)=0$ , or 1 we can get a good result in almost any case.

### 1. 緒言

前論文では東西方向の wave number が零の場合について調べた。この論文では東西方向に zonal でない場合について調べる。zonal でない場合について HOUGH による continued fraction の方法 (HOUGH, 1897, 1898) は3つの場合に大別される。ここではその1つの方法 (LHK法と名付ける) について調べる。以下に述べるこの方法は、まだほとんど何も調べられていない。

### 2. Continued fraction による基礎方程式系の解法

ここで, HOUGH の論文にしたがって計算方法の概略を述べる。東西方向に zonal でない Laplace の tidal equation は次の様にまとめられる。

$$\frac{4\omega^2\alpha^2}{ghs^2}\zeta + \frac{d}{d\mu} \left[ \frac{(1-\mu^2)\frac{d\zeta}{d\mu} - s\mu\zeta}{k^2 - s^2\mu^2} \right] - \frac{k^2\zeta}{(1-\mu^2)(k^2 - s^2\mu^2)} + \frac{s\mu}{k^2 - s^2\mu^2} \frac{d\zeta}{d\mu} = 0 \quad (1)$$

ただし

$$\mu = \cos\theta, \quad s = \frac{2\omega k}{\beta} = \frac{k}{f}. \quad (2)$$

また

$$f = \frac{\beta}{2\omega}. \quad (3)$$

他の記号については前の論文を参照されたい。

ここで

$$\zeta = - \left\{ (1-\mu^2) \frac{d}{d\mu} + s\mu \right\} \phi_1 - (k^2 - s^2\mu^2) \phi_2 \quad (4)$$

とおく。ただし,  $\phi_1$  および  $\phi_2$  は  $\mu$  の任意の関数である。 $\phi_1$  および  $\phi_2$  の間に

$$(\nabla^2 + s) \phi_1 = 2s^2\mu \phi_2 \quad (5)$$

\* 1992年11月7日受理。Received November 7, 1992.

\*\* 長崎大学教養部物理学教室, 〒852 長崎市文教町 1-14

Department of Physics, Faculty of Liberal Arts, Nagasaki University, 1-14 Bunkyo-machi, Nagasaki City, Nagasaki, 852 Japan.

Table I. Results of convergence by the method (a2) with varying the wave mode  $n$  and keeping the wave number  $k$  constant.

angular freq.	0.14544 E-03			
wave number	mode $n$			
symmetric	2	4	6	8
$k=2$	○	○	×	×
antisymmetric	3	5	7	9
$k=2$	○	×	×	×
angular freq.	0.72720 E-04			
wave number	mode $n$			
symmetric	1	3	5	7
$k=1$	○	×	×	×
antisymmetric	2	4	6	8
$k=1$	○	○	×	×

Table II. Results of convergence by the method (a1) with varying the wave mode  $n$  and keeping the wave number  $k$  constant.

angular freq.	0.14544 E-03			
wave number	mode $n$			
symmetric	2	4	6	8
$k=2$	○	○	○	×
antisymmetric	3	5	7	9
$k=2$	○	○	×	×
angular freq.	0.72720 E-04			
wave number	mode $n$			
symmetric	1	3	5	7
$k=1$	○	×	○	○
antisymmetric	2	4	6	8
$k=1$	△	○	×	×

が成り立つように選ぶ。

また、さらに

$$\zeta = \sum_{n=k}^{\infty} C_n^k P_n^k, \tag{6}$$

$$\phi_1 = \sum_{n=k}^{\infty} D_n^k P_n^k, \tag{7}$$

$$\phi_2 = \sum_{n=k}^{\infty} F_n^k P_n^k, \tag{8}$$

とルジャンドル陪関数で、 $\phi_1$ および $\phi_2$ を展開する。すると、方程式(1), (3), (4), (5), (6), (7), (8)から次の方程式が得られる。

$$x_{n-2}^k C_{n-2}^k - L_n^k C_n^k + y_n^k C_{n+2}^k = 0. \tag{9}$$

ここで

$$x_n^k = \frac{(n-k+1)(n-k+2)}{(2n+1)(2n+3)\{(n+1)(n+2)-2\omega k/\beta\}}, \tag{10}$$

$$y_n^k = \frac{(n+k+1)(n+k+2)}{(2n+3)(2n+5)\{(n+1)(n+2)-2\omega k/\beta\}}, \tag{11}$$

$$L_n^k = -\frac{gh}{4\omega^2 a^2} + \Lambda_n^k. \tag{12}$$

ただし、(12)式の $\Lambda_n^k$ は

$$\Lambda_n^k = \frac{\beta^2}{4\omega^2} \frac{n(n+1)-2\omega k/\beta}{n^2(n+1)^2} - \frac{(n-1)^2(n-k)(n+k)}{n^2(2n-1)(2n+1)\{(n-1)(n+2)-2\omega k/\beta\}} - \frac{(n+2)^2(n-k+1)(n+k+1)}{(n+1)^2(2n+1)(2n+3)\{(n+1)(n+2)-2\omega k/\beta\}} \tag{13}$$

また、ここで新しい記号 $H_n^k, K_n^k$ を導入する。

$$H_n^k = \frac{x_n^k y_n^k}{L_n^k} \frac{x_{n-2}^k y_{n-2}^k}{L_{n-2}^k} \dots \frac{x_k^k y_k^k}{L_k^k} \left[ \text{または} \frac{x_{k+1}^k y_{k+1}^k}{L_{k+1}^k} \right] \tag{14}$$

Table III. Results of convergence by the methods (b1),(b2),(c1),(c2),(c3) and (c4) with the results by the methods (a1) and (a2) for comparison.

angular freq.		0.14544 E-03			
symmetric		mode $n$			
	wave number	2	4	6	8
a1	$k=2$	○	○	×	×
a2	$k=2$	○	○	○	×
b1	$k=2$	○	○	×	×
b2	$k=2$	○	○	×	×
c1	$k=2$	○	○	○	×
c2	$k=2$	○	○	×( $n=4$ )	×( $n=6$ )
c3	$k=2$	○	○	×( $n=8$ )	×( $n=6$ )
c4	$k=2$	○	○	×( $n=8$ )	×( $n=6$ )

antisymmetric		mode $n$			
	wave number	3	5	7	9
a1	$k=2$	○	×	×	×
a2	$k=2$	○	○	×	×
b1	$k=2$	○	○	×	×
b2	$k=2$	○	×	×	×
c1	$k=2$	○	○	○	×
c2	$k=2$	○	○	×	×
c3	$k=2$	○	○	×	×
c4	$k=2$	○	○	×	×

Table III-2

angular freq.		0.14052 E-03			
symmetric		mode $n$			
	wave number	2	4	6	8
a1	$k=2$	○	○	×	×
a2	$k=2$	○	○	○	×( $n=6$ )
b1	$k=2$	○	○	×	×
b2	$k=2$	○	○	×( $n=8$ )	×( $n=14$ )
c1	$k=2$	○	○	×( $n=4$ )	×( $n=6$ )
c2	$k=2$	○	○	×( $n=4$ )	×( $n=10$ )
c3	$k=2$	○	○	×( $n=4$ )	×( $n=6$ )
c4	$k=2$	○	○	×( $n=4$ )	×( $n=6$ )

antisymmetric		mode $n$			
	wave number	3	5	7	9
a1	$k=2$	○	×	×	×
a2	$k=2$	○	○	×( $n=5$ )	×( $n=7$ )
b1	$k=2$	○	×	×	×
b2	$k=2$	○	○	×( $n=11$ )	×( $n=7$ )
c1	$k=2$	○	×( $n=3$ )	×( $n=13$ )	×
c2	$k=2$	○	○	×( $n=11$ )	×( $n=7$ )
c3	$k=2$	○	×( $n=13$ )	×	×( $n=7$ )
c4	$k=2$	○	○	×( $n=13$ )	×( $n=15$ )

$$K_n^k = \frac{x_{n-2}^k y_{n-2}^k}{L_n^k} \cdot \frac{x_n^k y_n^k}{L_{n+2}^k} \dots \quad (15)$$

$$K_n^k = \frac{x_{n-2}^k y_{n-2}^k}{L_n^k - K_{n+2}^k} \quad (17)$$

(14), (15)式は, また, 次のように表せる。

これら  $H_n^k, K_n^k$  を用いると, (9)式は

$$H_n^k = \frac{x_n^k y_n^k}{L_n^k - H_{n-2}^k}, \quad (16)$$

$$L_n^k - H_{n-2}^k - K_{n+2}^k = 0 \quad (18)$$

となる。この(16)式が HOUGH function とその固有値

Table III-3

angular freq.		0.72720 E-04			
symmetric		mode <i>n</i>			
	wave number	1	3	5	7
a1	<i>k</i> =1	○	×	×	×
a2	<i>k</i> =1	○	×	○	○
b1	<i>k</i> =1	○	×	×	×
b2	<i>k</i> =1	○	×	×	×
c1	<i>k</i> =1	○	×	×	○
c2	<i>k</i> =1	○	×	×	×
c3	<i>k</i> =1	○	○	×	○
c4	<i>k</i> =1	○	×	×	○
antisymmetric		mode <i>n</i>			
	wave number	2	4	6	8
a1	<i>k</i> =1	○	○	×	×
a2	<i>k</i> =1	△	○	×	×
b1	<i>k</i> =1	○	○	×	×
b2	<i>k</i> =1	○	○	×	×
c1	<i>k</i> =1	○	○	○	×
c2	<i>k</i> =1	○	○	○	×
c3	<i>k</i> =1	○	○	×	×
c4	<i>k</i> =1	○	○	×	×

を求める方程式となる。

3. 数値計算の方法

(16)式より  $H_{n-2}^k=0$ ,  $K_{n+2}^k=0$ と仮定して,  $L_n^k=0$ を解いて, 第1近似値  $R_1$  ( $\equiv \frac{gh}{4\omega^2 a^2}$ ) を求める。

$$R_1 = \Lambda_n^k$$

つぎに, この  $R_1$ を用いて, 必要な精度 (ここでは3桁) を得るに必要な  $H_{n-2}^k$  と  $K_{n+2}^k$  の最大の項を決めておく。ここでは,  $H_{n-2}^k$  については  $H_n^k$  か  $H_{n+1}^k$  までとり,  $K_{n+2}^k$  についてはほとんどの場合,  $K_{n+22}^k$  項までとれば良いことがわかった。 $H_{n-2}^k$ ,  $K_{n+2}^k$ を用いて,  $R_1$  に対する, 誤差  $E_1 = L_n^k - H_{n-2}^k - K_{n+2}^k$  を計算しておく。つぎに, 第2近似値  $R_2$  とその誤差  $E_2$  を求めるのであるが, それについていろいろな場合に分けて,  $R_2$  以後の近似の求め方の違いによる解の収束性を調べた。調べた場合は, 角振動数については,  $0.19910 \times 10^{-6} \text{sec}^{-1}$  (1年周期),  $0.39820 \times 10^{-6} \text{sec}^{-1}$  (半年周期),  $0.72720 \times 10^{-4} \text{sec}^{-1}$  (一日周期),  $0.14544 \times 10^{-3} \text{sec}^{-1}$  (太陽半日周期),  $0.21817 \times 10^{-3} \text{sec}^{-1}$  (太陽1/3日周期),  $0.14052 \times 10^{-3} \text{sec}^{-1}$  (太陰半日周期) である。東西方向の波数については波数  $k=1 \sim 10$  までについて, また南北方向の振動モードについてはモード  $n=1 \sim 10$  までについて調べた。したがって, 波数とモードの組み合わせによって, 赤道に対

して, 対称なモードと反対称なモードに分けられてくる。すなわち,  $|k-n|$  が偶数の時は対称モードであり,  $|k-n|$  が奇数の時は反対称モードである。

4. 計算した具体的な場合とその結果

(a) 数値計算は第2近似の計算の仕方によって分類して調べた。まず, 第一に(a), (b), (c)のように大別され, (a), (b), (c)についてはさらに, 具体的な場合について分けられる。

(a1) まず第一に, この方法は zonal な場合の論文(古賀他, 1991) の(a)の方法と本質的には全く同じである。 $R_1$ を用いて次の式をつぎつぎと計算する。

$$L_{n+2}^k = -R_1 + \Lambda_{n+2}^k$$

$$L_{n-2}^k = -R_1 + \Lambda_{n-2}^k$$

そこで  $K_{n+4}^k=0$  と仮定して

$$K_{n+2}^k = \frac{x_{n-2}^k y_n^k}{L_{n+2}^k}$$

また,  $H_{n-4}^k=0$  と仮定して

$$H_{n-2}^k = \frac{x_{n-2}^k y_{n-2}^k}{L_{n-2}^k}$$

を求める。これらを用いて

$$R_2 \equiv \frac{hg}{4\omega^2 a^2} = \Lambda_n^k - H_{n-2}^k - K_{n+2}^k \tag{19}$$

Table IV. Results of convergence by the methods (b2) and (b1) with keeping the wave mode  $n$  constant and varying the wave number  $k$ .

angular freq.	0.72720 E-04	$n=7$	
symmetric	wave number	d2	d1
	1	×	×
	3	×	×
	5	○	×
	7	○	○
antisymmetric	2	×	×
	4	×	×
	6	×	×
angular freq.	0.14052 E-03	$n=8$	
symmetric	wave number	d2	d1
	2	×	×
	4	× ( $n=6$ )	×
	6		○
	8		○
antisymmetric	1	× ( $n=4$ )	×
	3	× ( $n=6$ )	×
	5	○	×
	7	○	○
angular freq.	0.14544 E-03	$n=8$	
symmetric	wave number	d2	d1
	2	× ( $n=6$ )	×
	4	○	×
	6	○	○
	8	○	○
antisymmetric	1	× ( $n=4$ )	×
	3	× ( $n=6$ )	×
	5	○	×
	7	○	○

これより、第2近似値  $R_2$  を求める。同様に、第3近似以後にても、近似回数を一回増すごとに  $K_{n+2}^k$ ,  $H_{n-2}^k$  の continued fraction の項をそれぞれ1項づつ増して行って(19)の右辺で求める。この際勿論、 $H_j^k$  で  $j < k$  の場合は  $H_j^k = 0$  とする。また、 $K_j^k$  については  $j \geq n+22$  の場合も  $K_j^k$  は零とおいた。

その結果は表 I のようであった。角振動数  $0.19910 \times 10^{-6} \text{sec}^{-1}$  (1年周期) 及び  $0.39820 \times 10^{-6} \text{sec}^{-1}$  (半年周期) は収束しなかったので省いた。また、 $0.14052 \times 10^{-3} \text{sec}^{-1}$  (太陰半日周期) の収束性は  $0.14544 \times 10^{-3} \text{sec}^{-1}$  (太陽半日周期) と同じであったので省いてある。

(a2) つぎに参考のため次の場合も調べた。第2, 第3近似は同じである。また、近似を1回重ねるごとに  $K_{n+2}^k$ ,  $H_{n-2}^k$  の continued fraction の項を1項づつ増すのもこれまで通りである。ただし、第4近似以後では  $i$  番目の近似値  $R_i$  は  $(i-2)$  と  $(i-1)$  の近似値  $R_{i-2}$ ,  $R_{i-1}$  とその誤差  $E_{i-2}$

$$E_{i-2} = L_n^k - H_{n-2}^k - K_{n+2}^k \quad (20)$$

および、 $E_{i-1}$  を用いて、次の式の内挿 (又は外挿) によって求める。

すなわち、

$$R_i = \frac{E_{i-2} R_{i-1} - E_{i-1} R_{i-2}}{E_{i-2} - E_{i-1}} \quad (21)$$

これらの計算結果が表 II にまとめてある。

(b) このグループの方法は  $H_{n-2}^k$  の項は初めから  $H_n^k$  又は  $H_{n+1}^k$  まで、 $K_{n+2}^k$  では  $K_{n+2}^k$  項まで計算で用いた。また、第2近似値  $R_2$  の求め方の違いによって、さらに2つに分けて調べてみた。

(b1) この方法は第2近似値  $R_2$  を次の式にしたがって求めた。まず、 $R_1$  よりその誤差  $E_1$  を(20)にしたがって求め、この  $E_1$  を用いて

$$R_2 = E_1 + \Lambda_n^k$$

より求める。さらに第3近似以後の近似、例えば  $i$  番号



Table V. Results of convergence by the methods (b2) (b1) with varying both the wave mode  $n$  and the wave number  $k$ .

angular freq.	0.14052 E-03	f2	f1
symmetric	$k=3, n=3$	○	○
	$k=5, n=5$	○	○
	$k=7, n=7$	○	○
	$k=9, n=9$	○	○
antisymmetric	$k=3, n=4$	○	○
	$k=5, n=6$	○	○
	$k=7, n=8$	○	○
	$k=9, n=10$	○	○
angular freq.	0.14544 E-03	f2	f1
symmetric	$k=3, n=3$	○	○
	$k=5, n=5$	○	○
	$k=7, n=7$	○	○
	$k=9, n=9$	○	○
antisymmetric	$k=3, n=4$	○	○
	$k=5, n=6$	○	○
	$k=7, n=8$	○	○
	$k=9, n=10$	○	○
angular freq.	0.72720 E-03	f2	f1
symmetric	$k=2, n=2$	○	×
	$k=4, n=4$	×	×
	$k=6, n=6$	○	○
	$k=8, n=8$	○	○
antisymmetric	$k=2, n=3$	○	○
	$k=4, n=5$	○	×
	$k=6, n=7$	×	×
	$k=8, n=9$	×	×
angular freq.	0.21817 E-03	f2	f1
symmetric	$k=4, n=4$	○	○
	$k=6, n=6$	○	○
	$k=8, n=8$	○	○
	$k=10, n=10$	○	○
antisymmetric	$k=4, n=5$	○	○
	$k=6, n=7$	○	○
	$k=8, n=9$	○	○
	$k=10, n=11$	○	○

の近似では(20)式より  $E_{i-1}$  を求める。また、 $R_i$  は

$$R_i = R_{i-1} + E_{i-1} \quad (22)$$

より求める。この方法は前の論文(松島他, 1991)の方法(I)と同類である。

(b2) この方法は第2近似値  $R_2$  を求めるまでは、方法(b1)と全く同じである。第3番目の近似値  $R_3$  では  $R_2$ ,  $R_1$  および誤差  $E_2$ ,  $E_1$  を用いて(21)式で計算した。また、この時、同様に誤差  $E_i$  も(20)より計算しておく。以後、この方法を収束するまで繰り返す。つぎに、以下のグループについても計算してみた。

(c) この方法は、第2近似までは(a1)の方法と同じで

あるが、第3近似以後で用いる  $H_{n-2}^k$ ,  $K_{n+2}^k$  の計算では(b)と同じく  $H_{n-2}^k$  では初めから  $H_n^k$ , 又は  $H_{n+1}^k$  を用い、 $K_{n+2}^k$  では  $K_{n+22}^k$  項まで用いる。また、第3近似以後の求め方でいろいろ分けて調べた。

(c1) これらより  $R_2$  を(16)式を用いて、また、この  $R_2$  に対する誤差  $E_2$  も(20)式より計算する。第3近似以後は(21)式を用いて  $i$  番目の近似値  $R_i$  を求める。

(c2) この方法は第2近似値  $R_2$  までは(c1)と全く同じであるが、第3近似値  $R_3$  は以下のように求める。 $R_2$  を用いて

$$L_{n+2}^k = -R_2 + A_{n+2}^k,$$

$$L_{n+4}^k = -R_2 + \Lambda_{n+4}^k,$$

$$L_{n-2}^k = -R_2 + \Lambda_{n-2}^k,$$

$$L_{n-4}^k = -R_2 + \Lambda_{n-4}^k,$$

を計算する。さらに  $K_{n+4}^k$  の計算では  $K_{n+6}^k=0$  と仮定して

$$K_{n+4}^k = \frac{x_{n+2}^k y_{n+2}^k}{L_{n+4}^k}.$$

さらに

$$K_{n+2}^k = \frac{x_n^k y_n^k}{L_{n+2}^k - K_{n+4}^k}.$$

また,  $H_{n-4}^k$  の計算では  $H_{n-6}^k=0$  と仮定して

$$H_{n-4}^k = \frac{x_{n-4}^k y_{n-4}^k}{L_{n-4}^k}.$$

また

$$H_{n-2}^k = \frac{x_{n-2}^k y_{n-2}^k}{L_{n-2}^k - H_{n-4}^k}$$

を計算して  $R_3$  を(19)式の右辺から求め, その誤差  $E_3$  も求めておく。以下  $i$  番目の近似値  $R_i$  は(21)式から求める。

(c3) 第3近似までは(c2)と全く同様で, それ以後の近似も本質的には全く同じである。すなわち, 第4近似値  $R_4$  を求めるとき,  $L_{n+2}^k, L_{n+4}^k, L_{n+6}^k, L_{n-2}^k, L_{n-4}^k, L_{n-6}^k$  を計算する。さらに  $K_{n+6}^k$  の計算では  $K_{n+8}^k=0$  と仮定して式(17)から求め, 以後順々と  $K_{n+4}^k, K_{n+2}^k$  を求める。 $H_{n-2}^k$  についても, まず  $H_{n-8}^k=0$  と仮定して(16)から  $H_{n-6}^k, H_{n-4}^k, H_{n-2}^k$  を求める。それ以後は(19)の右辺より  $R_4$  を求め, またその誤差  $E_4$  は(20)から求める。第5近似以後は(21), (20)を用いて収束するまで求める。(c4) 第4近似根  $R_4$  を求めるまでは(c3)と同じであるが, さらに  $R_4$  を用いて,  $\Lambda_i^k, K_i^k, H_i^k$  を計算して, (22)式を用いて第5近似値  $R_5$  を求め, さらにその誤差  $E_5$  を計算する。第6近似以後は(21)式で近似値  $R_i$  を求める。

これらの結果を表Ⅲに表した。

以後の場合は東西方向の wave number  $k$  が零の場合に非常に良い結果をもたらした(b1), (b2)の方法を用いて調べた。

(d) まず, mode  $n$  を一定にして,  $k$  の変化でどの様に収束性が変るかを調べた。

この結果を表Ⅳに表している。

(f) つぎに,  $k$  と共に  $n$  も共に増加した場合の収束性

を調べた。この結果を表Ⅴに表している。

### 計算結果

全体として言えることは, 角振動数が小さくなると収束は悪くなる。例えば, 角振動数が  $0.19910 \times 10^{-6} \text{sec}^{-1}$  の場合には, 収束が余りにも遅く, 考えているルジャンドル陪関数の項数を20項とっても収束しないことが解った。また角振動数  $0.39820 \times 10^{-6} \text{sec}^{-1}$  では, ある  $k$  と  $n$  の場合には項数20項では収束しなかったり, 他の  $k$  と  $n$  の場合には遅すぎたり, 収束はするが得られた結果が他の場合の  $k$  と  $n$  の解が得られなかった。そこで良い結果は全ての方法で一つも得られなかった。一方, 角振動数が大きくなり, 例えば  $0.21817 \times 10^{-3} \text{sec}^{-1}$  では, 全ての方法で良い結果が得られ, 収束も速かった。そこで, 上の3つの角振動数の場合の結果は表から除いてある。

一般的に言えることは, 前の論文の結果と同じく角振動数が大きくなると収束性は良い。また, 東西方向の波数  $k$  と南北方向の mode  $n$  の差  $|n-k|$  が小さいほど収束性は良く, 差が大きくなると別の  $k$  と  $n$  の値に収束したり(収束の安定性が悪い), 収束の速度が著しく悪くなったりすることが解った。なかんずく, 特別に収束の良い方法は, この例の中には見当たらない。しかし, 内挿(又は外挿)による方法は, 比較的収束が速かった。

方法(a1)と(a2)を比較してみると, (a2)の方法がいくらか優れている。さらに, 方法(b1)と(b2)では(b2)の方法がいくらか良さそうである。方法(a2)と方法(b2)では  $k=1$  で対称モードでは(a2)の方が良さそうであるが, 特別良いとは言えない。方法(c1), (c2), (c3), (c4)では, 方法(c1)が一番良さそうである。また, 調べた全ての方法の中でも方法(c1)が一番良さそうである。しかし, 特別優れているとは言えない。

計算表Ⅳ, 表Ⅴから言えることは  $n$  と  $k$  の差が小さいほど, 収束性は良い。特に  $(n-k)=0$  又は1の場合には角振動数  $0.72720 \times 10^{-4} \text{sec}^{-1}$  を除いて全ての場合で求まっている。

### 5. 結 論

この方法では, 特に優れた方法はなかった。その中でも方法(c1)がいくぶん勝っているように見える。また, 収束に関して一般的に言えることは, 角振動数が大きくなれば収束は速く, 収束の安定性も良い。また, 東西方向の波数  $k$  と南北方向のモード  $n$  の差  $(k-n)$  が大きくなれば, 収束は著しく悪くなり, 収束の安定性も悪くなる。逆に  $(k-n)=0$ , または1の場合には, ほとんどの場

合解が求まる。

文 献

- HOUGH, S. S.(1897): On the application of Harmonic analysis to the dynamical theory of tides, Part I. Phil. Trans. Roy. Soc. London, **A189**, p.201.
- HOUGH, S. S.(1898): On the application of Harmonic analysis to the dynamical theory of tides, Part II. Phil. Trans. Roy. Soc. London, **A191**, p.139.
- 古賀雅夫・後藤信行・松島晟(1991): Laplace の Tidal equation -continued fraction による解の収束性について-. *La mer*, **29**, 62-66.
- 松島晟・古賀雅夫・後藤信行(1991): Laplace の Tidal equationの解—continued fraction 法による固有値の計算で収束しない原因とその改良法—. *La mer*, **29**, 90-96.

日仏海洋学会賞受賞記念講演

海洋における窒素循環の研究\*

小池 勲夫\*\*

Study on nitrogen dynamics in the ocean\*

Isao KOIKE\*\*

皆様のご推薦により、この度日仏海洋学会賞を頂くことになり、本当にありがたいことと感謝致しております。これを機会に、これまでの研究をさらに発展させ、研究者としての夢の一部なりともかなうよう努力したいと存じています。ここでは、私とその共同研究者が行ってきた海洋の窒素循環の研究のうち、海底堆積物における無機態窒素の動態の研究に焦点を絞って紹介していきたいと思います。

さて、海洋科学の分野において、窒素循環の研究は生物を主体とした個々の窒素代謝と関連したもの、あるいは栄養塩や有機窒素化合物の動態と微生物群集との関係を論じる等の仕事が多く、なかなか海洋における窒素循環を統合的に扱った研究は少ないのが現状です。私の窒素循環への取り組みも、大学院の時に進んでいた実験室での脱窒素細菌のエネルギー生理学的研究を、海洋というフィールドで発展させる手始めとして、東京湾で脱窒素活性を重窒素でラベルした硝酸イオンをトレーサーとして測定を試みたことから始まりました。<sup>15</sup>Nを使った脱窒素活性の測定は、修士課程の時にすでに浜名湖で少し行ったことがあり、嫌気条件下の底層水では極めて高い活性を得ることが出来たので、東京湾の水でもなんら問題なく活性の測定が出来るものと楽観しておりました。しかしまた実験を始めた年は、東京湾における夏季の貧酸素層の発達が悪く、有為な活性が検出出来ないままに、ある時堆積物の表層を使って測定してみたのが堆積物の窒素循環を始めるきっかけになりました。堆積物表層では、1-2時間の<sup>15</sup>N硝酸イオンの添加で極めて高

い活性が得られ、これは他の季節でも、大きくは変わらないことが示されたからです。現場条件での活性測定にいろいろ方法上の問題はあっても、常に強い代謝活性が得られることは大きな利点であるので、研究の場を水中から海底堆積物へと乗り換えることにしました。

私が堆積物の仕事を始めた70年代の半ば頃は、海底堆積物の微生物活性、特に無機態窒素循環に関与した活性を測定した仕事は乏しかったため、重窒素をトレーサーとして使う利点を生かして、硝酸イオンの動きと微生物代謝を関係させたいいくつかの研究を発表することが出来ました。その一つは、嫌気的な硝酸還元のプロセスが脱窒素へ向かう系と、アンモニア生成へ向かう系とに分かれ、堆積物の環境条件の違いでその比率がかなり異なってくることを明らかにしたことであります。これまで実験室での培養菌では、嫌気的な硝酸還元で脱窒素細菌のように分子体窒素などを生成せず、アンモニア生成を伴う菌がいることはよく知られており、私もこのような菌の1種を用いて、生理学的な実験をしていました。しかし、自然条件下でこのような菌が活発に働いていることを明らかにしたのは、沿岸堆積物でのこの実験が初めてでした。我々の実験では、より酸化的な堆積物において脱窒素活性がより強い位の事しか言えませんでした。しかし、その後80年代の始めに、主にアメリカのグループによって、環境中の硝酸還元の基質である有機炭素と、硝酸還元呼吸系の末端電子受容体である硝酸イオンとの存在比が重要であることが、異なったタイプの硝酸還元菌の群集が分布する、土壌・堆積物・活性汚泥等による実験で明らかにされています。次に、硝酸還元・脱窒素の電子受容体である堆積物中の硝酸イオンの起源について、底層水から拡散で堆積物中に供給される部分と、堆積物中での硝化作用によって生成される部分とがあることを、<sup>15</sup>N硝酸イオンによる同位体希釈法を用いて明らかにすることが出来ました。海洋における窒素循環の研

\* 1992年5月31日日仏会館(東京)で講演  
Conférence la remise du Prix de la Société  
franco-japonaise d'océanographie

\*\* 東京大学海洋研究所東京都中野区南台1-15-1  
Ocean Research Institute, The University of  
Tokyo, 1-15-1 Minamidai, Nakano, Tokyo,  
164 Japan

究で、アンモニアの代謝研究には、これまでも同位体希釈法がしばしば使われてきましたが、硝酸イオンの代謝に使われたのは、この研究がおそらく始めてであり、感度はあまり良い方法とは言えませんが、二つの独立の窒素代謝である硝化系と硝酸還元系を同時に測定出来る手法としては唯一のものです。

堆積物での硝酸還元・脱窒素の基質である硝酸イオンの供給に関しては、その後、我々の測定値に加えてアメリカやデンマークでの有機物供給の多い沿岸域堆積物での測定例を併せて検討を最近行っています。その結果、このような沿岸の泥質堆積物表層での脱窒素の現場活性は、底層水での硝酸イオン濃度にほぼ比例していることが明らかになりました。この比例関係は、底層での硝酸イオン濃度が数 $\mu\text{M}$ から数100 $\mu\text{M}$ までの広い範囲で当てはまることから、有機物に富んだ沿岸堆積物では、堆積物中での硝化作用によって供給される硝酸イオンに対し、底層水起源の硝酸イオンの方が脱窒素に大きな役割を果たしていることが示唆されます。またここで得られた関係式と、各沿岸域での底層水中の水温や硝酸イオン濃度などの一般的データを使って、海域スケールでの堆積物での脱窒素の規模を推定することも可能になりました。

海洋の窒素循環の中で、脱窒素がどのくらいの役割を果たしているかについては、 $^{15}\text{N}$ トレーサー法で脱窒素の速度を沿岸域の堆積物で推定する仕事を行って来ました。これらの研究の結果、海底堆積物、特に表層での有機物供給が多い沿岸や、縁辺海での堆積物表層での脱窒素量がかなりの規模になることに気がつきました。海底堆積物中での脱窒素の測定に関しては、 $^{15}\text{N}$ トレーサー法の他に、脱窒素細菌による亜酸化窒素の窒素ガスへの還元が、アセチレンの添加によって阻害されることを利用した、アセチレンブロック法が、測定の容易なことあって広く使われるようになりました。さらに最近では、高精度の溶存窒素ガスの分析法を用いて、ベルジャー中での窒素ガスの脱窒素による増加を直接計測する手法など

が開発され、堆積物で脱窒素速度の推定値がかなり出るようになりました。これらの結果、従来海洋での窒素収支の中で、脱窒素の生じている場として知られていた、太平洋東部熱帯域やインド洋の貧酸素水塊などでの脱窒素量と、同じ位の規模で脱窒素が沿岸や縁辺海での堆積物表層で起こっていることが推定されるようになりました。

亜酸化窒素は、硝化系でも脱窒素系でも生成される、大気中の微量ガス態窒素化合物で、温室効果気体あるいは地球のオゾン層の破壊に関与する気体として近年その動態が特に注目されるようになってきました。堆積物中の亜酸化窒素の動態については、それが微量であることから、ほとんど測定例はありませんでしたが、80年代の後半になって、堆積物コア試料を加圧抽出する事によって、堆積物表層での間隙水中成分の微細分布を明らかにする方法がアメリカで開発されました。さっそくこの方法を亜酸化窒素に応用した所、数mm間隔での堆積物表層での亜酸化窒素の微細鉛直分布を得ることが出来ました。この手法では、亜酸化窒素だけでなく、硝酸・亜硝酸イオンといった無機態窒素化合物や、溶存酸素などのパラメーターも同じ間隔で測定できるので、同時に亜酸化窒素の生成過程について多くの情報を得ることが出来るほか、堆積物からの亜酸化窒素のフラックスについても推定が可能です。

以上、私がこれまで行って来た研究のうち、堆積物中の無機態窒素の循環に関するものをまとめて見ましたが、海洋での有機窒素の循環はさらに複雑で、その微生物との関わりは大変興味深いものです。今後は、今までも多少手がけていた有機窒素・炭素の動態と微生物の働きに研究の主眼を移して、海洋の窒素循環の全体像の把握を目標として行きたいと思います。最後になりましたが、私の大学院の指導教官であり又窒素代謝研究の先達でもあった東京大学名誉教授の服部明彦先生に深く感謝致したいと思います。

## 学 会 記 事

1. 1992年5月26日(火)東京水産大学において平成4, 5年度幹事候補者による懇談会が開かれた。主要な議事は下記のとおり。
  - 1) 日仏関連学会連絡協議会(1991.12.5日仏会館)の報告
  - 2) 日仏学者交換(日仏会館)に関する候補者推薦について
  - 3) La mer 編集刊行について
  - 4) 1992-93年度幹事分担(案)について
  - 5) 平成4年度評議員会提出の議案について
2. 1992年5月26日(火)東京水産大学において平成4年度評議員会が開かれた。主要な議事は下記のとおり。
  - 1) 平成4, 5年度評議員選挙結果報告および評議員追加についての審議  
 会員の選挙により選出された50名の評議員に、佐伯和昭、渡邊精一の2氏を追加することを承認した。
  - 2) 平成4, 5年度会長選挙結果報告
  - 3) 平成4, 5年度副会長, 幹事, 監事の選出  
 (以上新役員・評議員等については別記参照)
  - 4) 平成3年度事業報告
  - 5) 平成4年度学会賞受賞候補者選考経過報告
  - 6) 平成3年度収支決算及び監査報告
  - 7) 会則の改正について  
 原案どおり承認した。  
 学生会員の適用方法等についての論議があり、実状に即して弾力的な運用を行うことを確認した。
  - 8) 平成4年度事業計画案審議
  - 9) 平成4年度収支予算案審議
  - 10) 平成5年度学会賞受賞候補者推薦委員会委員選出  
 (別記参照)
  - 11) その他
    - a) 感謝状の贈呈について
    - b) 会長から特に学生会員の入会推薦についての依頼があった。
    - c) 編集幹事からLa merへの積極的な投稿の呼びかけがあった。特に学生会員制度を活用して大学院生からの投稿をはたらきかけることを確認した。
3. 1992年6月1日(月)日仏会館会議室において平成4年度日仏海洋学会学術研究発表会が開催された。発表題目と発表者は下記のとおり。

### プ ロ グ ラ ム

午前(9:30~11:50)

1. 三大洋及び地中海における海中分光照度分布  
 ……………○今関昭博・森永勤(東水大)
2. 1989年11月下旬および1991年12月上旬の日本-赤道XBT観測……………○須藤英雄・吉田次郎・松山優治・栗田嘉宥・峰雄二(東水大)
3. 西部赤道太平洋における係留観測システム(JAPACS 91)……………○稲葉栄生・川畑広紀・守屋洋(東海大海洋)
4. Vertical distribution of *Mesodinium rubrum* in Maqueda Bay, western Samar, Philippines in relation to tidal and diel environmental changes  
 ……………○Filipina B. Sotto and Yusho Aruga(東水大)
5. マルマラ海の基礎生産構造について  
 ……………山口征矢(埼玉大教養)
6. サロマ湖における冬季および夏季の微細藻類の脂肪酸の比較……………○佐藤博雄(東水大)・山口征矢(埼玉大)・竹内俊郎(東水大)・渡辺研太郎(極地研)
7. フィリピン産シャトネラの成長特性  
 ……………○石丸隆・二ノ方圭介・村野正昭(東水大)

午後(13:00~14:40)

8. アミの保育行動  
 ……………村野正昭・○佐藤弘康・石丸隆(東水大)
9. アワビの自動行動記録装置の開発  
 ……………○森川由隆・松生治(東水大)  
 特別講演: 中国・台湾・ハワイにおける海藻事情  
 ……………三浦昭雄(青森大)
4. 1992年6月1日(月)日仏会館会議室において第33回(平成4年度)総会が開催された。議事の概要は下記のとおり。
  - 1) 平成3年度事業報告
    - a) 庶務  
 会員移動状況

	3年4月	入 会	退 会	4年4月
名誉会員	3	—	—	3
正 会 員	312	0	10	302
賛助会員	24	0	2	22

平成4, 5年度評議員, 役員選挙及び選出

活動状況

評議員会 1回(5/29)

幹事会 2回(5/29, 11/22)

総会 1回(5/31日仏会館)

学術研究発表会 1回(5/31日仏会館)

日仏オーシャンフлакスワークショップの開催  
(主催 日仏会館, 東大海洋研, 日仏海洋学会  
11/25-11/27日仏会館)

講演会の開催(主催 日仏会館, 日仏海洋学会,  
日仏理工科会 11/28 日仏会館)

「炭素循環を支配する海洋」J.G.デュプレッシー,  
G.ジャック(国立科学研究センター)

「深海の世界」M.シブエ(国立海洋開発研究所),  
A.ディネ(国立科学研究センター)

第6回日仏学術シンポジウム(第3回日仏海洋シ  
ンポジウム7/2-5ナントへの参加)

学会誌 La mer の発行(28/4, 29/1, 2)

日仏海洋学会創立30周年記念出版「海に何が起こっ  
ているか」(岩波ジュニア新書の刊行)

学会賞授与 今脇資郎(鹿児島大学)(5/31 日  
仏会館)

日仏会館学者交換事業(日仏会館)候補者の推薦  
佐伯和昭(10/23-11/10 渡仏)

平成4, 5年度評議員, 会長選挙(資料)

日本学術会議第15期研究連絡委員会委員候補者の  
推薦  
海洋科学研究連絡委員会 関 文威  
水産学研究連絡委員会 隆島史夫

## b) 編集

La merを3号[28/4, 29/1, 29/2]刊行, 合計  
222頁

(28/4は日仏シンポジウム(1990.11.13-14  
日仏会館)プロシーディングズで135頁)  
29/3は7月刊行見込み, 29/4は日仏ワークショッ  
プ(1991.11.25-27日仏会館)プロシーディン  
グズ

現在の手持ち原稿 原著論文7編, 資料2編

## c) 平成4, 5年度役員, 評議員選出結果報告

佐伯和昭, 渡邊精一両幹事を評議員に追加する。

## d) 平成4年度学会賞受賞候補者選考経過報告

## 2) 平成3年度収支決算報告及び監査報告

平成三年度決算 平成三年度予算

## 収入

前年度 繰越金 555,764 (555,764)

正会員会費	1,476,000	(1,872,000)
	(延246名内2年度50名)	
賛助会員会費	250,000(17社25口)	(330,000)
学会誌売上金	223,844	(210,000)
広告料	80,000	(280,000)
著者負担印刷費	556,674	(350,000)
雑収入	531,984	(19,000)
	〔印税収入 447,949〕	
	〔日仏会館 70,000〕	
	〔利子他 〕	
寄付金収入	0	(1)
計	3,674,266	計 3,614,765

## 支出

学会誌等印刷費	1,873,569	(2,450,000)
	(27-4~28-4 1部)	
送料・通信費	194,200	(300,000)
事務費	715,126	(700,000)
	(人件費, 事務用品, 封筒他)	
交通費	27,190	(30,000)
会議費	28,758	(30,000)
	(評議会, 幹事会, 学会賞)	
学会賞経費	71,320	(75,000)
雑費	36,076	(29,765)
	(総会手伝, 郵便, 銀行手数料他)	
次年度繰越金	728,027	
計	3,674,266	計 3,614,765

## 3) 会則改正案審議

下記原案どおり改正することを決議した。

現行 第7条 本会会員は本会の目的に賛成し,  
所定の会費を納めるものとする。  
会員は正会員および賛助会員とす  
る。

改正案 第7条 本会会員は本会の目的に賛成し,  
所定の会費を納めるものとする。  
会員は正会員, 学生会員および賛  
助会員とする。

現行 第8条 正会員会費は年額6,000円, 賛助  
会員会費は一口年額10,000円とす  
る。

改正案 第8条 正会員会費は年額6,000円, 学生  
会員会費は年額4,000円, 賛助会  
員会費は一口年額10,000円とする。

## 4) 平成4年度事業計画案審議

評議員会1回, 総会1回, 学術研究発表会1回,

幹事会 4 回  
シンポジウム及び講演会の開催  
学会誌の発行 (4 号)  
平成 4 年度学会賞授賞及び平成 5 年度学会賞受賞  
候補者推薦  
その他

5) 平成 4 年度収支予算案審議  
平成四年度収支予算 (案)

収入

前年度 繰越金	728,027
正 会 員 会 費	1,812,000 (302名×6,000円)
学生会員 会費	40,000 (10名×4,000円)
賛助会員 会費	320,000 (22社32口)
学会誌 売上金	220,000
広 告 料	200,000 (5万/号×4号)
著者負担印刷費	300,000
雑 収 入	20,000
寄 付 金 収 入	1
計	3,640,028

支出

学会誌等印刷費	2,450,000 (60万/号×4号)
送料・通信費	300,000
事 務 費	700,000
交 通 費	30,000
会 議 費	30,000
学 会 賞 経 費	75,000
雑 費	15,000
予 備 費	40,028
計	3,640,028

6) その他

高橋正前幹事の永年に亘る学会への貢献に対して感謝状の贈呈が行われた。引き続いて、小池勲夫会員への学会賞授賞と学会賞受賞記念講演 (座長山口征矢会員) が行われた。また、別室で懇親会が開かれ、盛会裡に終了した。

5. 1992年6月17日 (水) 日仏会館会議室において日仏会館、日仏海洋学会主催で下記の講演会が開催された。「珊瑚の生態系の研究と長期的監視」ミッシェル・リカール (ボルドー第3大学教授)

6. 1992年8月31日 (月) 東京水産大学において平成4年度第1回幹事会が開かれた。主要な議事は下記のとおり。

1) 平成4年度科学研究費補助金「研究成果公開促進費」の審査結果について

2) シンポジウム「地球環境と水産業—地球にやさしい海の利用」の共催を承諾した。

(日本学術会議水産学研究連絡委員会主催 1992.8.7日本学術会議で開催)

3) 「イセエビの生物学と資源管理に関する国際ワークショップ」の共催を承諾した。

(国内組織委員会委員長 橋高二郎 1993.7.25~7.31北里大学水産学部で開催予定)

4) 理化学研究所第15回科学講演会への協賛を承諾した。

(1992.10.2 経団連会館)

5) フランクフルト・ブックフェア'92「学会誌」展示会 (1992.9.30-10.5) への La mer 出品手続きを行った。

6) 学協会著作権協議会主催「出版物の複写に係る権利の委託について」の説明会 (7月28日) が行われ、須藤幹事が出席した。学会としても前向きで検討することを考える。

7) 笹川日仏財団からトラベルファンドその他の日仏文化交流助成についての案内が届いている。会長が財団の担当者に会って詳細を確かめることとした。

8) 世界水産学会議について会長および隆島幹事 (日本学術会議水産学研究連絡委員会委員) から説明があった。運営経費の負担額については、研連委員会でのとり決めどおり、加盟学会の会員数に応じた分担率にしたがって、本学会は年額US\$62とすることを承認した。評議員にも通知して了承を得ることとする。

9) La mer 特集号 (JECSS VIプロシーディングズ) の刊行について高野評議員から依頼があった。JECSS VIは日仏海洋学会は後援であり、主催あるいは共催ではないので、今後のことも考慮し、下記の取扱いによることを確認した。

a) 本学会の学会誌にふさわしい内容であれば、経費や通常の編集に支障を来さない限り、受け入れる。

b) 経費および寄稿者の資格について下記の2条件を満足するよう協力を求める。

①印刷費の負担 (今回は21編あるので、100万円)

②非会員の寄稿者の入会

c) 責任ある編集委員会を組織し、編集作業を行う。また、計画がある場合は、なるべく早めに連絡してもらおうこととする。

10) 「会則」等の学会誌への掲載および「投稿の手引」



の改訂について

- a) 会費等を明確にするため、少なくとも年1回程度は会則を掲載する。
  - b) 非会員でも投稿できることとし、超過ページおよび非会員投稿のさいの印刷実費を明記する等「投稿の手引」の改訂案の作成を編集委員会に依頼した。
  - c) 会員名簿をできるだけ早い機会に印刷配布する。
- 11) その他

(財)東海水産科学協会(鳥羽市)から「海の博物館」開館の挨拶があった。このような関係施設の利用や入場には会員は特典を受けられるよう、事務局で具体的な方法を研究し、実現をはかる。

7. 1992年9月16日(水)日仏会館地下ホールにおいて日仏会館、日仏海洋学会主催で下記の講演会が開催された。

「海洋学の未来」ユベール・セカルディ(日仏会館学長離任記念講演)

8. 平成4年度日仏海洋学会賞

受賞者: 小池勲夫(東京大学)

受賞課題: 海洋の窒素循環に関する研究

推薦理由: 海洋の窒素循環の解明は海洋の生物生産過程の理解に不可欠な課題であるとともに、近年大きな問題となっている地球規模での海洋の炭素収支を考える上でも極めて重要な課題である。小池勲夫博士は、この窒素循環・窒素代謝に関する研究のアプローチを、海底堆積物中でのプロセスと主に海洋表層でのプロセスに分けて発展させた。堆積物については、 $15-N$ の安定同位体トレーサーを使って海底堆積物表層中の脱窒素、硝化等の速度を測定し、浅海堆積物での脱窒素が全海洋での脱窒素量の中に占める割合がかなり大きいことを示したのをはじめ、堆積物における硝化・脱窒素の両プロセスが密接にカップリングしていることを証明し、さらに $15-N$ トレーサーを用いて実験とモデルの双方において堆積物中の窒素循環プロセスを推定する方法を提唱するなど、多くの業績をあげている。

また、海洋表層におけるプロセスについての研究では、窒素循環、各種生物群集によるアンモニアの代謝を実験的に解析し、アンモニア取り込みのサイズ依存性、アンモニア取り込みと硝酸イオン取り込みとの関係を明らかにし、アンモニア $15-N$ 同位体希釈法を用いて表層生物群集によるアンモニアの再生産速度を測定した。また、細菌群集によるアンモ

ニアの取り込みならびに溶存有機窒素の分解によるアンモニア排出の調節機構などについても、多くの新しい知見を得ている。

さらに近年は、海洋中の微小粒子の動態と物質循環の研究にも着手し、海洋におけるコロイド粒子の分布やその代謝機構、あるいは海洋ウイルスの計数等の研究は、国内外で高い評価を得ている。

以上のように、小池勲夫博士は極めて活発に研究を展開しており、その成果は多くの論文として発表されている。海洋の窒素循環に関する近年の理解は小池博士の研究業績を参照せずに語るができないと言っても過言ではなく、彼の出席を得てこの分野の国際シンポジウム等が成果を挙げてきた。また、同博士は評議員ならびに幹事として本学会の発展に尽力し、1991年には本学会創立30周年記念刊行物の編集執筆を担当するなど、海洋学研究のみならず本学会の発展にも大きく寄与している。本委員会は小池勲夫博士の研究を高く評価し、本学会賞を受賞するにふさわしい候補者としてここに推薦するものである。

学会賞受賞候補者推薦委員会

委員長 谷口 旭

### 主要論文

1. Growth yield of denitrifying bacterium, *Pseudomonas denitrificans*, under aerobic denitrifying conditions. *J. Gen. Microbiol.*, **88**, 1-10 (1975). (with HATTORI, A.)
2. Energy yield of denitrification: an estimate from growth yield in continuous cultures of *Pseudomonas denitrificans* under nitrate-, nitrite- and nitrous oxide-limited conditions. *J. Gen. Microbiol.*, **88**, 11-19 (1975). (with HATTORI, A.)
3. Denitrification and ammonia formation in anaerobic coastal sediments. *Appl. Env. Microbiol.*, **35**, 278-282 (1978). (with HATTORI, A.)
4. Simultaneous determinations of nitrification and nitrate reduction in coastal sediments by a  $15-N$  dilution technique. *Appl. Env. Microbiol.*, **35**, 853-857 (1978). (with HATTORI, A.)
5. Estimates of denitrification in sediments of the Bering Sea shelf. *Deep-Sea Res.*, **26A**, 409-415 (1979). (with HATTORI, A.)
6. The use of enclosed experimental ecosystems to study nitrogen dynamics in coastal waters. *In*: G. D. GRICE and M. R. REEVE (eds.), *Marine Mesocosms: Biological and Chemical Research in Experimental Ecosystems*. Springer-Verlag,

- New York. p. 291-303 (1982). (with HATTORI, A. TAKAHASHI, M. and GOERING, J. J.)
7. Horizontal distribution of surface chlorophyll *a* and nitrogenous nutrients near Bering Strait and Unimak Pass. *Deep-Sea Res.*, **29**, 149-155 (1982). (with FURUYA, K., OTOBE H., NAHAL T., NEMOTO, T. and HATTORI, A.)
  8. High-affinity uptake of an ammonium analogue by two marine microflagellates from the oligotrophic Pacific. *Mar. Biol.*, **74**, 161-168 (1983). (with REDALJE, D. C., AMMERMAN, J. M. and HOLM-HANSEN, O.)
  9. Oxygen and inorganic nitrogen contents and fluxes in burrows of the shrimps *Callinassa japonica* and *Upogebia major*. *Mar. Ecol. Prog. Ser.*, **12**, 185-190 (1983). (with MUKAI, H.)
  10. Behavior and respiration of the burrowing shrimps *Upogebia major* (DE HAAN) and *Callinassa japonica* (DE HAAN). *J. Crust. Biol.*, **4**, 191-200 (1984). (with MUKAI, H.)
  11. Denitrification and nitrification in coastal and estuarine sediments. *In*: M. J. KLUG and C. A. REDDY (eds.), *Current Perspectives in Microbial Ecology*. American Society for Microbiology, Washington, D. C. p. 454-459 (1984). (with NISHIO, T. and HATTORI, A.)
  12. Inorganic nitrogen metabolism by Antarctic phytoplankton with special reference to ammonium cycling. *Mar. Ecol. Prog. Ser.*, **30**, 105-116 (1986). (with HOLM-HANSEN, O. and BIGGS, D. C.)
  13. Particle counter determination of bacterial biomass in seawater. *Appl. Env. Microbiol.*, **53**, 274-277 (1987). (with KOGURE K.)
  14. Role of sub-micrometre particles in the ocean. *Nature*, **345**, 242-244 (1990). (with HARA, S., TERAUCHI, K. and KOGURE, K.)
  15. Amino acid ammonium utilization by heterotrophic marine bacteria grown in enriched seawater. *Limnol. Oceanogr.*, **35**, 1145-1155 (1990). (with TUPAS, L.)
  16. Estimation of ammonification and ammonium assimilation in surficial coastal and estuarine sediments. *Limnol. Oceanogr.*, **35**, 270-286 (1990). (with SUMI, T.)
  17. Simultaneous uptake and regeneration of ammonium by mixed assemblages of heterotrophic marine bacteria. *Mar. Ecol. Prog. Ser.*, **70**, 273-282 (1991). (with TUPAS, L.)
  18. Abundance of viruses in marine waters: Assessment by epifluorescence and transmission electron microscopy. *Appl. Env. Microbiol.*, **57**, 2731-2734 (1991). (with HARA, S. and TERAUCHI, K.)

## お 知 ら せ

**The 6th International Conference on Toxic Marine Phytoplankton**

The 6th International Conference on Toxic Marine Phytoplankton will be held in Nantes, France, from October 18 to 22, 1993. The purpose of this international scientific meeting is to study noxious or toxic species of marine phytoplankton, their proliferation in coastal areas or in the open sea and their effects on human health, aquaculture and biological resources. The general increase in microalgal proliferations, their geographical spread and the appearance of new harmful species have required a broadening of the research fields concerned with this worldwide problem, e. g., ecology, taxonomy, physiology, immunology, molecular biology, toxicology and epidemiology. The communications and posters presented will subsequently be published, after selection and revision by a reading committee.

6th International Conference on  
Toxic Marine Phytoplankton  
Cit  des Congr s  
5, rue de Valmy  
44041 Nantes cedex  
France

**第4回「イセエビの生物学と資源管理に関する  
国際ワークショップ」**

表記の国際ワークショップが、日仏海洋学会共催のもとに下記の日程で開催されます。

主催：ロブスターに関する国際ワークショップ組織委員会

会期：平成5年7月25日(日)～7月31日(土)

会場：北里大学水産学部 Marine Hall

セッション 総述者

1. 初期生活史 J. Booth (ニュージーランド)/  
B. Phillips (オーストラリア)
2. 沿岸回帰機構 S. Cobb (米国)
3. 生理学 L. Quakenbush (米国)
4. 生化学 金沢昭夫 (日本)
5. 水産養殖 橋高二郎 (日本)
6. 資源培養 J. Addison (英国)/  
R. Bannister (英国)
7. 漁業管理 P. Breen (ニュージーランド)

使用言語：英語

参加申込期限：平成5年4月20日

問い合わせ先：〒022-02岩手県気仙郡三陸町越喜来  
北里大学水産学部

第4回ロブスター国際ワークショップ組織委員会  
事務局

TEL : 0192-44-2121 FAX : 0192-44-2125

#### 魚介類の天然香料エキス

DES EXTRAITS AROMATIQUES NATURELS  
DES PRODUITS DE LA MER

フランスのプロバ(本社: モントルイユ・スー・ポア)は甲殻類・魚貝類から抽出した天然香料エキスのシリーズ製品“フラボセアン”(FLAVOCEAN)を完成・商品化した。

市場分析によれば、魚介類の消費は世界的に拡大基調にある。新鮮な魚介類だけでなく、その加工食品(スープ、ビスク、調理済み冷凍食品、ソース、缶詰、スナック菓子など)についても消費は伸びてきている。ところが今日まで、加工食品の製造に不可欠な原料や香料は、技術的にも商業的にも様々な問題を抱えていた。例えば、質の高い魚肉を使っても、香料に加工すると中位の品質のものしか得られないのに値段が高い。また、ペースト状香料や濃縮ソースは、保存に問題がある。合成香料は消費者の好みや欲求にあわない、など。フラボセアンは、ファインケミカル技術の分野でプロバが蓄えた香料原料の抽出・精製ノウハウに基づくもので、こうした短所を解決する画期的な製品である。フラボセアンは100%天然のエキスであり、芳香性のある液状または粉末状の製品。完全に水に溶け、すぐ薄めることができるので簡単に混合できる。芳香効率も良く、コスト/パフォーマンス比に優れている。

現在揃っている製品は、カニ、ロブスター、小エビ、ムール貝、まぐろ、白身魚、なま鮭、スモークサーモン、イワシのエキスである。香料メーカーはこれらのエキスを、魚介類香料の成分中で、ラストノート(残り香)、ベースノート、プレカーサー(前駆物質: その物質自体

香気はないが、熱あるいは酵素により分會した際香気を発するもの)として使うことができる。このエキスのもうひとつの販売対象は、食品メーカーである。原材料の代わりにこのエキスを使うことにより、製造工程の簡略化が可能となる。

プロバの工場はブルターニュ地方の、原料資源のとれる海のすぐ近くにある。同社では顧客と協力して、特別注文の製品を作ることもできる。(公報番号391)

会社名 PROVA

所在地 46, rue Colmet-Lépinay  
93100 MONTREUIL-SOUS-BOIS,  
FRANCE

TEL : (33) 42 87 36 76

FAX : (33) 42 87 10 13

TELEX : 212 513 F

日本代理店

シンベックス ジャパン株式会社

〒108東京都港区高輪2-19-17

高輪高陽ハイツ405

TEL : 03 (3446) 4790

FAX : 03 (3473) 0358

担当者 岩本

#### 水質検査用の測定システム

UNE CENTRALE D'ACQUISITION DE  
MESURE POUR LA QUALITE DE L'EAU  
フランスのソロマット社が開発・製造・商品化した“MPM 4000”プロセッサーと“4007”モジュールは、水質を分析するための高性能測定システムである。4007はポータブルな測定装置で、MPM 4000に直接接続できる。標準仕様の4007にはゾンデを接続する差し込みが7つついている。つまり4007は、データ収集に必要なソロマット製ゾンデと電極をMPM 4000プロセッサーと結ぶインターフェースの役割を果たしているのだ。4007のデジタル・キーボードで、ゾンデの種類、接続、測定単位を選択することができる。

このシステム全体では32種類の測定が可能であるが、特に下記のようなパラメーターを測定することができる。

- 白金センサーPt100での温度測定。このセンサーで、他のパラメーター用に温度補正をすることもできる。
- 伝導率。温度補正は任意。
- pH, mV, および酸化還元ポテンシャル。
- 超純水から廃水まで、あらゆる水の塩分濃度と電気抵抗率。

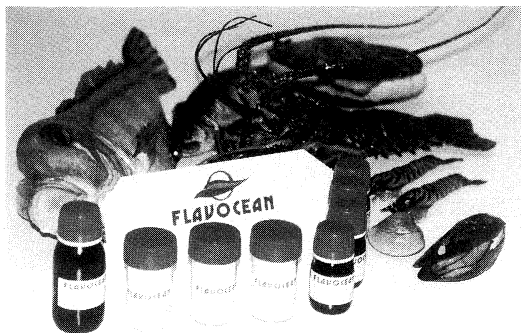

- 含有酸素。測定法としてガルバニー電気法またはポーラログラフ法を選択できる。塩分濃度の自動補正により、含有酸素の測定が精確になる。
- 直接測定または比濁分析法による濁度測定。センサーの汚れと光は自動的に修正される。
- あらゆる種類の選択電極（30種類のイオン）で測定するイオン濃度。
- 水深の測定。他の測定結果と共に記憶させることができる。

システム全体を管理するのは強力なマイクロプロセッサで、これがキャリブレーション、データの記憶、記録の開始/停止、上限・下限の警戒限度値、最大値、最小値、平均値の自動記録を行う。得られたデータは、MPM 4000/4007のディスプレイによって表示される。または、MPM 4000に外部プリンターやIMB/PCコンパチブル機を接続して、データを紙に印刷したりコンピューター画面に表示したりすることができる。それぞれのデータは、記憶した日時と測定地点コードと共に記録（最大10,000件）される。強力に適応性のあるソフトを使っているため、装置との対話、分析の実施、レポートの編集が可能。

MPM 4000/4007は、ポータブル用にも据え付け用にも使うことができ、さまざまな応用が考えられる。例えば、水源の水質調査、水流の監視、海洋調査、廃水処理、工場生産の検査、研究所用の複合的測定、実験室やプロセス用の多地点測定システムなど。このほか、ソロマットの“Minilab 4000”はコンパクトなIP66規格の防水タイプの測定装置で、集合センサー803PSを装備している。このセンサーが水質検査のキーパラメーターを記録し、センサーへの相互交換を可能にする。Minilab 4000は、苛酷な気象条件のもと、測定現場で長時間にわたって使用するために設計されたもので、メンテナンスも簡単である。

ソロマットでは、日本での輸入販売代理業者を探している。(公報番号423)

会社名 SOLOMAT

所在地 16, rue Jacques Tati, B. P. 187  
91006 EVRY CEDEX, FRANCE

TEL : (33) 1 60 77 89 90

FAX : (33) 1 60 77 93 73

TELEX : 601 441 F

担当者 Mrs. Michele DUMONT

ミッシェル・デュモン

### 日仏海洋学会役員・評議員

(1992-1993年度)

顧問 : ユーベル・プロシェ ジャン・デルサルト  
ジャック・ローベル アレクシス・ドラ  
ンデル ベルナル・フランク ミシェ  
ル・ルサージュ ロベール・ゲルムール  
ジャック・マゴー レオン・ヴァンデルメ  
ルシュ オーギュスタン・ベルク ユーベ  
ル・セカルディ

名誉会長 : オリビエ・アンサール

会長 : 有賀祐勝

副会長 : 高木和徳 岡市友利

幹事 : (庶務) 須藤英雄 有元貴文  
(会計) 松生 洽 森永 勤  
(渉外) 佐伯和昭 隆島史夫  
(研究) 小池勲夫 関 文威  
(編集) 山口征矢 渡邊精一

監事 : 久保田穰 辻田時美

編集委員長 : 村野正昭

評議員 :

青山恒雄 有賀祐勝 有元貴文 石井丈夫  
石野 誠 石丸 隆 今脇資郎 宇野 寛  
大塚一志 岡市友利 梶浦欣二郎 金成誠一  
鎌谷明善 国司秀明 黒木敏郎 黒田一紀  
小池勲夫 佐伯和昭 坂本市太郎 坂本 亘  
杉森康宏 須藤英雄 関 文威 関根義彦  
平 啓介 高木和徳 隆島史夫 高野健三  
高橋正征 竹松 伸 谷口 旭 辻田時美  
寺崎 誠 寺本俊彦 鳥羽良明 永田 豊  
奈須敬二 西沢 敏 畑 幸彦 平野敏行  
堀越増興 前田明夫 松生 洽 松村皐月  
松山優治 丸茂隆三 村野正昭 森永 勤  
柳 哲雄 山口征矢 和田 明 渡邊精一

### 平成5年度学会賞受賞候補者推薦委員会委員

青木三郎 阿部友三郎 石野 誠 今脇資郎  
落合正宏 鎌谷明善 小池勲夫 高野健三  
竹松 伸 谷口 旭 中村重久 松生 洽  
村野正昭 柳 哲雄 山口征矢

## 一 共同主催国際会議閣議了解得る 一

平成4年9月 日本学術会議広報委員会

平成5年度の日本学術会議の共同主催国際会議6件については、平成3年5月の第111回総会において決定されましたが、政府としても、本年6月30日の閣議において、これらの会議を日本で開催すること及び所要の措置を講ずることを了解しましたので、お知らせします。

### 平成5年度の共同主催国際会議の閣議了解

1. 日本学術会議では、昭和28年9月の国際理論物理学会議、昭和30年の国際数学会議の開催以来、平成3年度までに123件、本年度も6件の国際会議を関係の学会と共同して開催し、我が国のみならず世界の学術水準の向上に努めてきたところである。平成5年度にも、下記の6会議の共同開催を既に平成3年5月に決めているが、本年6月30日、政府全体としても、これらの会議の開催とこれについての所要の措置（会場・警備・入国手続き上の配慮・予算措置等）を講ずる旨の閣議了解を行った。

（平成5年度開催会議）

- ・アジア社会科学研究所協議会連盟第10回総会  
平成5年9月5日から11日（川崎市・かながわサイエンスパーク）
- ・第15回国際植物科学会議  
平成5年8月23日から9月3日（横浜市・横浜国際平和会議場）
- ・第7回太平洋学術中間会議  
平成5年6月27日から7月3日（沖縄県宜野湾市・沖縄コンベンションセンター）
- ・第24回国際電波科学連合総会  
平成5年8月23日から9月3日（京都市・国立京都国際会館）
- ・第21回国際純粋・応用物理学連合総会  
平成5年9月20日から25日（奈良県奈良市・奈良県新公会堂）
- ・第6回国際気象学大気物理学協会科学会議及び第4回国際水文科学協会科学会議合同国際会議  
平成5年7月11日から23日（横浜市・横浜国際平和会議場）

（閣議了解の内容）

〔各国際会議ごとに了解〕

- 1.（各会議名）を（共同主催学会名）と共同して平成5年度に我が国において開催すること。
  2. 関係行政機関は、上記会議の開催について所要の措置を講ずること。
2. なお、国際会議共同主催の申請から決定までのスケジュールはおおむね次のようになっている。
- ・会議開催3年前（年末まで）申請募集
  - ・会議開催2年前（2-3月頃）  
関係部会、運営審議会附置国際会議主催等検討委員会でのヒアリング等

（3-4月頃）

運営審議会での決定、総会への報告

・会議開催1年前

（6-7月頃）

閣議了解（政府としての共同主催正式決定）

共同主催学会との合意書締結、組織委員会の発足

現在本年年末締切りの平成7年度共同開催会議の募集を広報しているところである。（詳細は、日本学術会議月報をご覧ください。）

### 日本学術会議主催公開講演会

本会議では、毎年公開講演会を開催しています。この講演会には会員が講師となり、一つのテーマを学際的に展開しています。この秋には二つの講演会の開催が決まりましたので、お知らせします。多数の方々のご来場をお願いします。入場は無料です。

#### I 公開講演会「20世紀の意味と21世紀への展望」

日時 平成4年10月5日（月）13:30~16:30

会場 日本学術会議講堂

演題・演者

「国際政治の観点からー『長い平和』は持続可能か」

永井陽之助 第2部会員

（青山学院大学教授）

「文明的観点から」

弓削達 第1部会員

（フェリス学院大学学長）

「科学・技術の観点から」

伊達宗行 第4部会員

（大阪大学理学部長）

#### II 公開講演会「医学からみた日本の将来」

日時 平成4年11月28日（土）13:30~16:30

会場 金沢市文化ホール 大集会室

金沢市高岡町15-1 TEL 0762-23-1221

演題・演者

「子どもたち」

馬場一雄 第7部会員

（日本大学名誉教授）

「成人病」

五島雄一郎 第7部会員

（東海大学教授）

「医療技術の開発」

渥美和彦 第7部会員

（東京大学名誉教授）

「食物と栄養」

内藤博 第6部会員

（共立女子大学教授）

「医療制度の将来」

下山瑛二 第2部会員

（大東文化大学教授）

## 物理学研究連絡委員会報告 「物理学研究の動向と将来への課題」

7月24日の運営審議会において標記の報告の公表が承認された。1970年代から1980年代にわたって、日本の物理学の研究動向、研究環境を、かなり厳しい批判的スタンスで蒐集した客観的データに基づいて分析し、1990年代における日本の物理学の課題を展望しようとする野心的な報告である。日本の物理学研究・教育の将来を論ずるための不可欠の資料といえる。A4版112ページにまとめられており、日本物理学会の協力を得て、同学会会誌刷刷の形で関係者に公開される予定である。

本報告は、もともと第14期物理学研究連絡委員会が、久保亮五委員長らの提案に基づいて「物理学の研究・教育に関する調査小委員会」(委員長長岡洋介京大基研所長、幹事中井浩二高エネ研教授、委員小林俊一東大理、鈴木洋上智大理I、玉垣良三京大理、平田邦男山梨大教育、小沼通二慶大理の各教授)を設置してデータの蒐集・分析・要約を1990年7月から1991年5月にわたって精力的に行い、1990年6月20日の物理学研究連絡委員会全体会議に提出されたものである。第14期物研連任期終了に伴い、報告書及び今後の進め方についての取扱いを次期物研連への引継事項とした。これを受けて、第15期物理学研究連絡委員会は1992年5月22日の全体会議において本報告の取扱いについて協議し、公表を決定して中嶋貞雄委員長を通じて7月7日の第4部会での了承を求め、運営委員会に提案することとなった次第である。

本報告書が、日本の物理学の研究・教育に関心を寄せる多方面で活用されることを期待したい。

## 物理学研究連絡委員会報告 「理論物理学の研究体制の充実について」

7月24日運営審議会において標記の報告の公表が承認された。湯川秀樹博士のノーベル賞受賞にちなんで初の全国共同利用研究所として設置された京都大学基礎物理学研究所と一般相対論のユニークな研究で知られる広島大学理論物理学研究所は、1990年に統合され、内外の期待を集めつつ、理論物理学の総合的研究を目指す拡充・強化された基礎物理学研究所として再発足することとなった。しかし、現実には分野間の均衡が十分でなく、また北白川と宇治に建物が分離されている等、統合の実を十分に挙げ得ない現状である。

1992年5月22日の物研連全体会議は、このような状況の改善が速やかに改善され、理論物理学における日本の輝かしい伝統が復活されるよう、関係各方面に報告、支援を要請することとなった。

## 材料工学研究連絡委員会報告 「繊維工学研究・教育に関する諸問題」 産・学協力による繊維工学研究と教育の振興

わが国の繊維産業はかつて、日本を支える大産業であった。石油危機、貿易摩擦などによって低迷を余儀なくされた時期もあったが、今日では先端産業の要素技術ともなっ

て、その裾野を拡大し、また新合繊に象徴されるような高度機能商品を開発し、日本は世界のトップレベルを行く繊維技術国となった。現在繊維産業の従業員数は280万人、総取引額は約64兆円に達し、日本産業の中でも上位を占める基幹産業となっている。

この繊維産業を支える繊維科学技術教育を見ると、かつて国立大学には3つの繊維学部と、染色化学・加工学を含めて19の繊維関連学科があったが、産業構造の変化と共に改組転換されて、今日では繊維系学生の定員50人と激減するに至っている。大学院教育では、繊維学研究科の名称は一時期全廃された。その後、産・学の強い要望によって、平成3年に信州大学工学研究科に、繊維生物機能科学、繊維機能工学、繊維極限材料工学の3大講座が唯一設置されるに至った。

ところが、繊維産業の将来は、世界人口の増加、発展途上国の1人当たりの繊維消費量の増加から、繊維需要は膨大な成長力を秘めている。さらに、消費者主導型経済社会となって、ファッションにも、色、柄、デザインに加えて高機能性と加工技術が重要となってきた。また、繊維素材から最終商品までをシステム化した生産・物流技術、産業資材用途の拡大、地球環境改善への用途開発への期待高性能スーパー繊維による航空・宇宙、海洋、原子力、土木・建築分野への貢献、光ファイバーによる情報通信分野、中空糸による人工腎臓、酸素濃縮などヘルスケア分野、海水脱塩造水など先端分野でも重要な産業として自立しつつある。

こうした繊維産業発展の基礎となる高度技術の開発を促進し、その力を次世代へと継承させるためには、高度に訓練・教育された人材の育成が不可欠である。我が国にとって、繊維科学技術の研究・教育機構の再構築は焦眉の急となっている。これに対して、欧州ではEC統合を控え、各国の特徴に応じ産学協力し、繊維系大学の単位互換制度を指向するなど、繊維技術教育の再活性化に成功している。米国では繊維関連大学が十数校もあり、その中でノースカロライナ州立大学を繊維科学技術教育のセンターとして、ニューヨーク州立ファッション工科大学をアパレル・ファッション教育のセンターとして位置付けて、全世界へ人材を送り出している。

我が国で、産学協力して設立する機構としては、全国繊維関連大学、研究所、及び地域産業を結ぶ役割を持ち、我が国の優れた繊維工学知識の世界への発信と、国際的人材育成への寄与のため、欧州、米国と並ぶ、東アジアの繊維科学・技術の中心機構として活動することが望まれる。

この活動は、我が国に全世界の人々から期待されている国際貢献の一つとなろう。

御意見・お問い合わせ等がありましたら、下記までお寄せください。

〒106 東京都港区六本木7-22-34

日本学術会議広報委員会 電話03(3403)6291

La mer (Bulletin de la  
Société franco-japonaise  
d'océanographie)  
Tome 30 (1992)

Sommaire

Numéro 1

Article special

Present status of the Japan Sea chemical  
pollution: An overview ... A. V. TKALIN 1-4

Notes originales

The environmental conditions of the  
tuna's maneuvering sphere in the Bay  
of Bengal ..... Tsutomu MORINAGA,  
Akihiko IMAZEKI, Seiichi TAKEDA  
and Hisayuki ARAKAWA 5-16

Oceanic structure in the vicinity of a  
seamount, the Daini Kinan Kaizan,  
south of Japan ..... Yoshihiko SEKINE  
and Tatsuya HAYASHI 17-26

Characteristics of ciliated protozoa in-  
habiting colonies of pelagic blue-  
green algae ..... Masachika MAEDA,  
Mikio SUHAMA, Nobuo TAGA  
and Ryuzo MARUMO 27-32

The 1985 Chilean tsunami around Osaka  
Bay (in Japanese)  
..... Shigehisa NAKAMURA 33-37

Atmospheric eddy induced by a distant  
decaying typhoon observed at an off-  
shore oceanographic tower (in Japa-  
nese) ..... Shigehisa NAKAMURA 38-42

Faits divers

Unusual form of *Ecklonia stolonifera*  
Okamura (Laminariales, Phaeophyta)  
Masahiro NOTOYA and Yusho ARUGA 43-45

Proces-verbaux ..... 46-47

Numéro 2

Notes originales

Seasonal variation of meso- and macro-  
zooplankton in Tokyo Bay, central  
Japan (in Japanese)  
..... Hideaki NOMURA  
and Masaaki MURANO 49-56

Microzooplankton assemblages and its  
seasonal variation in Tokyo Bay,  
Japan (in Japanese)  
..... Hideaki NOMURA,  
Takashi ISHIMARU and  
Masaaki MURANO 57-72

うみ (日仏海洋学会誌)

第30巻 (1992年)

総目次

第1号

特別寄稿

日本海の化学的汚染の現況：概観 (英文)  
..... A. V. TKALIN 1-4

原 著

ベンガル湾におけるまぐろ・かじき類の環境  
条件 (英文) ..... 森永 勤・今関昭博・  
武田誠一・荒川久幸 5-16

日本南岸の第二紀南海山周辺の海洋観測  
(英文) ..... 関根義彦・林 辰哉 17-26

外洋水域の藍藻より分離した原生動物の繊毛  
虫の特徴 (英文) ..... 前田昌調・州浜幹雄・  
多賀信夫・丸茂隆三 27-32

大阪湾周辺における1985年チリ津波  
..... 中村重久 33-37

海洋観測塔で記録された遠隔台風による  
海上小規模禍 ..... 中村重久 38-42

資 料

ソルアラメの通常見られない形態 (英文)  
..... 能登谷正浩・有賀祐勝 43-45

学会記事 ..... 46-47

第2号

原 著

東京湾における・大型動物プランクトンの季  
節的消長 ..... 野村英明・村野正昭 49-56

東京湾の微小動物プランクトンとその季節的  
消長 ..... 野村英明・石丸 隆・村野正昭 57-72

深海大型二枚貝シロウリガイ "*Caly-  
ptogena*" *soyoeae* 及びその近縁種におけ  
る明確な2成長段階 (英文)  
..... 堀越増興・橋本 惇 73-82

Two distinct growth stages of a deep-sea, giant white clam, " <i>Calypptogena</i> " <i>soyoae</i> , and its allied species .....Masuoki HORIKOSHI and Jun HASHIMOTO	73—82	開口湾で観測された熱塩レンズについて .....中村重久	83—88
On thermohaline lens observed in a wide-open bay (in Japanese) .....SHIGEHISA NAKAMURA	83—88	資 料 マコンブ幼孢子体の脱分化細胞からの配偶体形成 (英文) .....能登谷正浩・有賀祐勝	89—91
<b>Faits divers</b> Formation of aposporous gametophytes from dedifferentiated young sporophyte cells of <i>Laminaria japonica</i> ARESCHOUG (Laminariales, Phaeophyta) .....Masahiro NOTOYA and yusho ARUGA	89—91		

### Numéro 3

#### Proceedings of the Sixth Japan and East China Seas Study Workshop

Preface .....	Kuh KIM	93
Meanders of the Tsushima Current .....	Takashi ICHIYE and Matthew HOWARD	95—103
Influence of surface water circulations on the sea bottom in the southern Japan Sea .....Ken IKEHARA		105—118
A laboratory model of thermally-driven marginal seas .....	Masaki TAKEMATSU	119—125
Dynamics of deep sea surface buoy system for ocean mixed layer experiment .....W. KOTERAYAMA, S. MIZUNO, K. MARUBAYASHI and M. ISHIBASHI		127—138
A numerical study on the barotropic transport of the Tsushima Warm Current .....Young Ho SEUNG and Soo Yong NAM		139—147
A note on initial nitrate and initial phosphate as tracers for the origin of East Sea (Japan Sea) Proper Water .....	Kyung-Ryul KIM, Tae Siek RHEE and Kuh KIM	149—155
Submarine cable voltage measurements between Pusan and Hamada .....Byung-Ho CHOI, Kuh KIM, Young-Gyu KIM, Kyung Soo BAHK, Jeong Ok CHOI and Kazuo KAWATATE		157—167
Ventilation of the Japan Sea waters in winter .....	A. S. VASILIEV and V. P. MAKASHIN	169—177
An estimation of extreme sea levels in the northern part of the Sea of Japan .....Alexander B. RABINOVICH, Georgy V. SHEVCHENKO and Svetlana E. SOKOLOVA		179—190
On the atmosphere-induced sea level variations along the western coast of the Sea of Japan .....	Svetlana E. SOKOLAVA, Alexander B. RABINOVICH and Kyo Sung CHU	191—212
On the distribution of bottom cold waters in Taiwan Strait during summertime .....Joe WANG and Ching-Sheng CHERN		213—221
The influence of Taiwan Strait waters on the circulation of the Southern East China Sea .....	Ching-Sheng CHERN and Joe WANG	223—228
Numerical simulation for a northeastward flowing current from area off the Eastern Hainan Island to Tsugaru/Soya Strait.....	R. LI, Q. ZENG, Z. JI and D. GUN	229—238
Numerical simulation of seasonal cycle of world ocean general circulations .....X.-H. ZHANG, N. BAO and W.-Q. WANG		239—250
Volume and heat transports of the Kuroshio in the East China Sea in 1989 .....Yaochu YUAN, Jilan SU and Ziqin PAN		251—262
Temporal and spatial variations in the Bottom Cold Water on the shelf off San'in coast, Japan .....	Yutaka ISODA and Hisaaki OOMURA	263—274
Wave characteristics changes under a strong tidal current influence .....Im Sang OH and Yoo Yin KIM		275—285
Mesoscale coherent structures in the surface wind field during cold air outbreaks over the Far Eastern seas from the satellite side looking radar .....	Leonid M. Mitnik	287—296
Lagrangian flow observations in the East China, Yellow and Japan Seas .....Robert C. BEARDSLEY, Richard LIMEBURNER, Kuh KIM and Julio CANDELA		297—314



## Numéro 4

### Généralités

- Distribution of elements in marine sediments: a review and synthesis  
 .....Noboru TAKEMATSU 315—337

### Notes originales

- Seasonal variation of photosynthetic properties of *Ecklonia cava* (Laminariales, Phaeophyta) in Nabeta Bay, central Japan  
 .....Richard HAROUN, Yusho ARUGA and Yasutsugu YOKOHAMA 339—348

- Colors of submerged objects observed from a viewpoint above the sea surface .....Tsutomu MORINAGA, Hisayuki ARAKAWA, Hiroo SATOH and anau MATSUIKE 349—363

- On the solution of Laplace's tidal equation (The convergence of the solution by the continued fraction method in the non-zonal case towards the east) (in Japanese)  
 .....Akira MATSUSHIMA and Masao KOGA 365—372

### Conference

- Study on nitrogen dynamics in the ocean (in Japanese) .....Isao KOIKE 373—374

- Proces-verbaux ..... 375—381

- Sommaire du Tome 30 ..... (1)—(3)

## 第 4 号

### 総 説

- 海底堆積物中の元素の分布：概観と合成  
 (英文).....竹松 伸 315—337

### 原 著

- 鍋田湾におけるカジメの光合成特性の季節変化 (英文) .....Ricardo HAROUN・有賀祐勝・横浜康継 339—348

- 海面上から見た水中物体の色 (英文)  
 .....森永 勤・荒川久幸・佐藤博雄・松生治 349—363

- Laplace の tidal equation の解 (東西方向に zonal でない場合の解法: continued fraction による収束性) について  
 .....松島 晟・古賀雅夫 365—372

### 記念講演

- 海洋における窒素循環の研究...小池 勳夫 373—374

- 学会記事..... 375—381

- 総目次 (第30巻) ..... (1)—(3)

## 賛 助 会 員

旭化成工業株式会社	東京都千代田区有楽町 1-1-2 三井ビル
株式会社 旭 潜 研	東京都北区栄町 9-2
阿 部 嘉 方	東京都練馬区春日町 2-15-6
株式会社 内田老鶴園 内 田 悟	東京都文京区大塚 3-34-3
有限会社 英和出版印刷社	東京都北区中里 2-7-7
株式会社 カ イ ジ ョ ウ	東京都西多摩郡羽村町栄町 3-1-5
財 海 洋 生 物 環 境 研 究 所	東京都千代田区内神田 1-18-12 北原ビル内
株式会社 川 合 海 苔 店	東京都大田区大森本町 2-31-8
三 信 船 舶 電 具 株 式 会 社	東京都千代田区神田 1-16-8
株式会社 自然・情報環境研究所	横浜市栄区桂町 1-1, 3-401
昭 和 電 装 株 式 会 社	高松市寺井町 1079
新 日 本 気 象 海 洋 株 式 会 社	東京都世田谷区玉川 3-14-5
全 日 本 爬 虫 類 皮 革 産 業 連 合 会	東京都足立区梅田 4-3-18
株式会社 高 岡 屋	東京都台東区上野 6-7-22
株式会社 鶴 見 精 機	横浜市鶴見区鶴見中央 2-2-20
株式会社 東京久栄技術センター	埼玉県川口市芝鶴ヶ丸 6906-10
株式会社 東急フーズミート	東京都品川区東品川 4-10-21
株式会社 西日本流体技研	長崎県佐世保市棚方町 283
日本アクアラング株式会社	神奈川県厚木市温水 2229-4
株式会社 日立造船技術研究所 バイオ研究センター	大阪市此花区桜島1-3-22
宮 本 悟	東京都中央区かきどき 3-3-5 かちどきビル 狛本地郷
株式会社 読 売 廣 告 社	東京都中央区銀座 1-8-14
渡 辺 機 開 工 業 株 式 会 社	愛知県渥美郡田原町神戸大坪 230
株式会社 渡 部 計 器 製 作 所	東京都文京区向丘 1-7-17

応援します。  
 良い海苔づくり—

生海苔活性調整機

RS-2型

海苔の等級が数段あがる

※生海苔を活性化し、海苔製品の表面をなめらかに  
 光沢よく仕上げます。

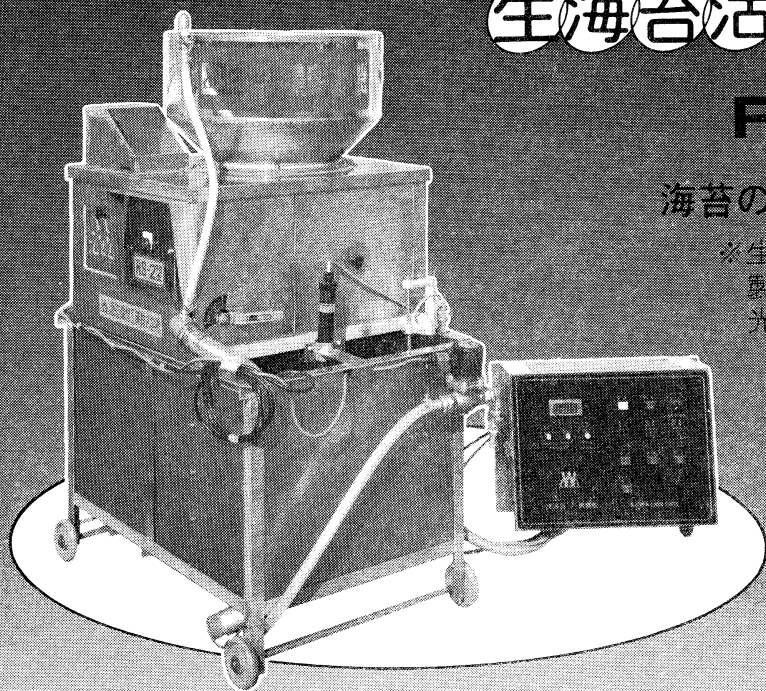

	RS-1型	RS-2型
高 寸	770mm	1,410mm
幅	960mm	950mm
機 体	860mm	780mm
実 重	65kg	180kg
	40W 1台	40W 2台
	100W 1台	60W 1台
モーター		100W 1台
		150W 1台



渡辺機開工業株式会社

愛知県渥美郡田原町神戸大坪230  
 電話 05312 (2) 1121 (代 表)



## 日 仏 海 洋 学 会 編 集 委 員 会 (1992-1993)

委 員 長: 村野正昭

委 員: 青木三郎, 有元貴文, 半沢正男, 堀越増興, 前田 勝, 落合正宏, 須藤英雄, 山口征矢, 柳 哲雄

海外委員: H. J. CECCALDI (フランス), E. D. GOLDBERG (アメリカ), T. ICHIYE (アメリカ), T. R. PARSONS (カナダ)

幹 事: 渡辺精一, 山口征矢

### 投 稿 の 手 引

1. 「うみ」(日仏海洋学会機関誌; 欧文誌名 *La mer*) は, 日仏海洋学会正会員およびそれに準ずる非会員からの投稿(依頼稿を含む)を, 委員会の審査により掲載する。
2. 原稿は海洋学および水産学両分野の原著論文, 原著短報, 総説, 書評, 資料などとする。すべての投稿は, 本文, 原図とも正副2通とする。副本は複写でよい。本文原稿用紙はすべてA4判とし, 400字詰原稿用紙(和文)に, または厚手白紙にダブル・スペース(和文ワープロでは相当間隔)で記入する。表原稿および図説明原稿は, それぞれ本文原稿とは別紙とする。
3. 用語は日, 仏, 英3か国語の何れかとする。ただし, 表および図説明の用語は仏文または英文に限る。原著論文(前項)には約200語の英文または仏文の要旨を, 別紙として必ず添える。なお, 欧文論文には, 上記要旨の外に, 約500字の和文要旨をも添える。ただし, 日本語圏外からの投稿の和文要旨については編集委員会の責任とする。
4. 投稿原稿の体裁形式は最近号掲載記事のそれに従う。著者名は略記しない。記号略号の表記は委員会の基準に従う。引用文献の提示形式は, 雑誌論文, 単行本分載論文(単行本の一部引用を含む), 単行本などの別による基準に従う。
5. 原図は版下用として鮮明で, 縮尺(版幅または1/2版幅)に耐えられるものとする。
6. 初校に限り著者の校正を受ける。
7. 正会員に対しては7印刷ページまでの掲載を無料とする。ただし, この範囲内であっても色彩印刷を含む場合などには, 別に所定の費用を著者負担とすることがある。正会員の投稿で上記限度を超える分および非会員投稿の印刷実費はすべて著者負担とする。
8. すべての投稿記事について, 1篇あたり別刷50部を無料で請求できる。50部を超える分は請求により, 50部単位で作製される。別刷請求用紙は初校と同時に配布される。
9. 原稿の送り先は下記の通り。

〒108 東京都港区港南4-5-7 東京水産大学 村野正昭 気付

日仏海洋学会編集委員会

1992年11月25日 印刷  
1992年11月28日 発行

う み 第30巻  
第4号

定 価 1,600

編 集 者 村 野 正 昭  
発 行 所 日 仏 海 洋 学 会  
財団法人 日仏会館内  
東京都千代田区神田駿河台2-3  
郵便番号: 101  
電話: 03(3291)1141  
振替番号: 東京 5-96503

印 刷 者 佐 藤 一 二  
印 刷 所 有 限 会 社 英 和 出 版 印 刷 社  
東京都北区中里2-7-7  
郵便番号: 114  
電話: 03(5394)4856

SOMMAIRE

Généralités

- Distribution of elements in marine sediments: a review and synthesis  
 .....Noboru TAKEMATSU 315

Notes originales

- Seasonal variation of photosynthetic properties of *Ecklonia cava*  
 (Laminariales, Phaeophyta) in Nabeta Bay, central Japan  
 .....Richard HAROUN, Yusho ARUGA and Yasutsugu YOKOHAMA 339
- Colors of submerged objects observed from a viewpoint above the sea surface  
 .....Tutomu MORINAGA, Hisayuki ARAKAWA,  
 .....Hiroo SATOH and Kanau MATSUIKE 349
- On the solution of Laplace's tidal equation (The convergence of the solution by the  
 continued fraction method in the non-zonal case towards the east) ( in Japanese)  
 .....Akira MATSUSHIMA and Masao KOGA 365

Conférence

- Study on nitrogen dynamics in the ocean ( in Japanese ) .....Isao KOIKE 373

Procès-verbaux

- ..... 375

- Sommaire du Tome 30 ..... (1)-(3)

第 30 卷 第 4 号

目 次

総 説

- 海底堆積物中の元素の分布：概観と合成（英文） .....竹松 伸 315

原 著

- 鍋田湾におけるカジメの光合成特性の季節変化（英文）  
 .....Ricardo HAROUN・有賀祐勝・横浜康継 339
- 海面上から見た水中物体の色（英文） .....森永 勤・荒川久幸・佐藤博雄・松生 治 349
- Laplace の tidal equation の解（東西方向に zonal でない場合の解法：  
 continued fraction による収束性）について .....松島 晟・古賀雅夫 365

記念講演

- 海洋における窒素循環の研究 .....小池勳夫 373

- 学会記事 ..... 375

- 総目次（第30巻） ..... (1)-(3)